

English

**OWNER'S  
MANUAL**  
**eagle** *edge*

**CE**  
2460



**DABI ATLANTE**

**PAGE LEFT INTENTIONALLY BLANK**

### MANUAL PRESENTATION

**GMDN:** 61019 - Cone beam computed tomography system, head/neck

**Trade Name:** Dental CT Scanner AXR

**Models:** AXR90 B, AXR120 B

**Brand:** Eagle Edge / Dabi Atlante

**Basic UDI-DI:** 78995813DentalCTAXR90B9J, 78995813DentalCTAXR120B2N

**Technical Responsible:** Daniel R. de Camargo

CREA-SP: 5062199650

**ANVISA Registration N°:** 10101130088



Alliage S/A Industrias Médico Odontológica  
Rodovia Abrão Assed, Km 53 + 450m - CEP 14097-500  
Ribeirão Preto - SP - Brazil  
Phone: +55 (16) 3512-1212



CINTERQUAL – Soluções de Comércio  
Internacional, Lda.  
Avenida Defensores de Chaves, N° 4  
Escritório Idea Spaces  
1000-117 Lisboa, Portugal

Publication Number: 77000001862 - Rev.: 00 - September/23

Document originally written in the Portuguese.

## TRADEMARKS

All terms mentioned in this manual that are either well-known trademarks, registered commercial trademarks or service marks have been properly labeled as such. Other products, services or terms that are mentioned in this manual can be registered trademarks, registered commercial trademarks or service marks of their respective owners. Alliage S / A makes no claim to these trademarks. The use of a term in this manual should not be considered as an influence on the validity of any trademark, registered commercial trademark or service mark.

Eagle Edge is an Alliage S/A registered commercial trademark.

Dabi Atlante is an Alliage S/A registered commercial trademark.

Microsoft, Windows, .NET Framework, Microsoft Visual C++ 2010, Report Viewer 2012 RunTime, System CLR Types for SQL Server 2012 are trademarks registered by Microsoft Corporation in the United States and in other countries.

MacOS is a commercial trademark registered by Apple Inc.

PostgreSQL is a database maintained by Oracle.

Java is programming language maintained by Oracle.

eBUS™ is a trademark from Pleora Technologies .

Copyright © 2019 Alliage S/A. All rights reserved.

The performance characteristics provided in this manual are for reference only and should not be considered as assured specifications.



## CONTENTS

<b>01</b>	<b>GENERAL INFORMATION</b>	<b>08</b>
1.1.	DEAR CUSTOMER	08
1.2.	INDICATION OF USE	08
1.3.	CONTRAINDICATION	08
1.4.	SYMBOLOLOGY	08
<b>02</b>	<b>WARNINGS, CAUTIONS AND RECOMMENDATIONS</b>	<b>14</b>
<b>03</b>	<b>SYSTEM GENERAL DESCRIPTION</b>	<b>21</b>
3.1.	DESCRIPTION OF SYSTEM	21
3.2.	MAIN COMPONENTS OF THE PRODUCT	22
3.2.1.	Panoramic only	22
3.2.2.	Panoramic with Cephalostat	23
3.2.3.	Panoramic Mult Slice	24
3.2.4.	Panoramic Mult Slice with Cephalostat	25
3.2.5.	Tomography only	26
3.2.6.	Tomography with Cephalostat	27
3.2.7.	Tomography 0.2FS	28
3.3.	SETS AND ACCESSORIES	29
3.3.1.	Positioners Kit	29
3.3.2.	Carpal support kit	29
3.3.3.	Free standing base	30
3.3.4.	QA kit	30
3.3.5.	Hygienic protective covers	31
3.3.6.	Prosthesis support	31
3.4.	APPLIED PARTS	32
3.5.	USER CONTROL INTERFACE	33
3.5.1.	Main control panel	33
3.5.2.	Cephalostat control panel	34
3.5.3.	Local and remote exposure control	34
3.5.4.	Emergency stop button	35
3.6.	LABEL POSITIONING	35
3.7.	SYSTEM REQUIREMENTS	36
3.7.1.	Software requirements	36
3.7.2.	Hardware requirements	37
3.7.3.	Location of installation	38
3.8.	SYSTEM LAYOUT	39
<b>04</b>	<b>OPERATION</b>	<b>41</b>
4.1.	INITIAL PREPARATION	41
4.2.	SNAP SENSOR	42
4.3.	PATIENT REGISTRATION	43
4.4.	PATIENT PREPARATION	46
4.5.	PANORAMIC EXAM	47
4.6.	CEPHALOMETRIC EXAM	58
4.7.	TOMOGRAPHY EXAM	63
4.8.	SCAN	71
4.9.	RECOMMENDATIONS FOR PEDIATRIC EXAMINATIONS	73
<b>05</b>	<b>DOSE INFORMATION</b>	<b>77</b>
5.1.	DOSE CALCULATION	77
5.1.1.	DAP for panoramic and cephalometric exam	77

5.1.2.	DAP for tomography exam	79
5.2.	SCATTER RADIATION	79
5.3.	RECOMMENDED X-RAY EXPOSURE TABLE	84
<b>06</b>	<b>CLEANING, DISINFECTION AND STERILIZATION</b>	<b>101</b>
<b>07</b>	<b>TROUBLESHOOTING</b>	<b>104</b>
7.1.	WARNING AND ERROR MESSAGES	104
7.2.	PROBLEM WITH UNIT OPERATION	104
7.3.	PROBLEM WITH PATIENT POSITIONING	105
<b>08</b>	<b>QUALITY DIAGNOSES</b>	<b>113</b>
8.1.	PANORAMIC QUALITY DIAGNOSIS	114
8.1.1.	Geometric calibration	115
8.1.2.	Spatial resolution	116
8.2.	CEPHALOMETRIC QUALITY DIAGNOSIS	117
8.2.1.	Calibration	117
8.2.2.	Spatial resolution	118
8.3.	TOMOGRAPHIC QUALITY DIAGNOSIS	119
8.3.1.	Contrast scale	120
8.3.2.	Slice thickness	120
8.3.3.	Spatial resolution	120
8.3.4.	Uniformity	121
8.3.5.	Noise	122
8.3.6.	Low contrast detectability	122
8.4.	DOSE MEASUREMENT	122
8.5.	QA REPORT	122
<b>09</b>	<b>INSPECTION AND MAINTENANCE</b>	<b>124</b>
9.1.	PERIODIC INSPECTION	124
9.2.	PREVENTIVE MAINTENANCE	125
9.3.	CORRECTIVE MAINTENANCE	126
9.4.	ALLIAGE AUTHORIZED SERVICE NETWORK	127
<b>10</b>	<b>WARRANTY</b>	<b>129</b>
<b>11</b>	<b>STANDARDS AND REGULATIONS</b>	<b>131</b>
<b>12</b>	<b>TECHNICAL SPECIFICATIONS</b>	<b>133</b>
12.1.	EQUIPMENT CLASSIFICATION	133
12.2.	DEVICE INFORMATION	134
12.3.	RADIOLOGIC INFORMATION	135
12.4.	X-RAY GENERATOR	137
12.5.	X-RAY TUBE	139
12.6.	SENSOR CHARACTERISTICS	143
12.7.	IMAGE MAGNIFICATION	143
12.8.	ENVIRONMENTAL CONDITIONS	144
<b>13</b>	<b>ELECTROMAGNETIC COMPATIBILITY</b>	<b>146</b>
13.1.	GUIDANCE AND DECLARATION FOR ELECTROMAGNETIC EMISSIONS	146
13.2.	GUIDANCE AND DECLARATION FOR ELECTROMAGNETIC IMMUNITY	147
<b>14</b>	<b>PROTECTING YOUR IMAGING SYSTEM FROM CYBERSECURITY THREATS</b>	<b>152</b>

## GENERAL INFORMATION

## 1. GENERAL INFORMATION

### 1.1. DEAR CUSTOMER

Congratulations for the excellent choice. Upon buying equipment under the EAGLE quality, you are acquiring a product with a technology compatible with the best equipment of the world in their category. The present manual offers a general overview of your equipment, describing important details that will direct you in its correct usage, as well as in solution of minor problems that eventually may occur. No additional training is required other than reading of the present manual. This manual should be read completely before initial use of the equipment and maintained for future queries.

### 1.2. INDICATION OF USE

The Dental CT Scanner AXR is designed to obtain radiological images of the oral anatomy, including teeth, maxillofacial areas, oral structures, carpal images and head-neck bone regions, and the same system, use should be handled by health professionals with qualification and duly qualified.

### 1.3. CONTRAINDICATION

The equipment is contraindicated for:

- Individuals in treatment with thyroid cancer radioiodine.
- Individuals with allergies to polyvinylpyrrolidone (PVC) or substances used in its manufacturing process, such as bisphenol A, adipic polyester, propylene glycol compound and ethylhexyl maleate.

### 1.4. SYMBOLOGY

The following symbols are used throughout this manual as well as in the product. Make sure that you fully understand each symbol and follow the instructions that accompany it.



Fragile, handle with care



Stacking limit by number



Keep away from rain

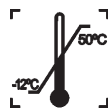

Temperature limit



This way up



Center of gravity



Keep away from sunlight



Do not walk or stand here



Recyclable



Unique Device Identification



Reference / Product Code



Serial number



Manufacturer



Model



Date of manufacture



Medical device



Indicates that this product has been evaluated as related to specific properties, a limited range of risks or suitability for use under limited or special conditions by the UL



Indicates which equipment complies with Directives 2011/65/EU and 2015/863/EU on the Restriction of Use of Certain Hazardous Substances in Electrical and Electronic Equipment.



Authorized representative in the European community



Indicates that equipment complies with Regulation (EU) 2017/745 of the European Parliament and of the Council of 5 April 2017 on medical devices



Type B applied part



**Ionizing Radiation**  
To indicate the presence or potential presence of ionizing Radiation / Physiological Effect



Electrostatic Sensitive Devices (ESD)



Focal Spot Localization



Focal Spot



Caution



Emergency stop



Protective ground



Dangerous voltage



Conductor of phase 1



**Biphasic configuration:**  
Conductor of phase 2  
**Single-phase configuration:**  
neutral phase



Alternate current

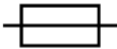

Fuse

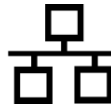

Ethernet Connector

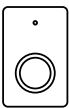

Remote Exposure Control Connector



**Off**  
(power: disconnect from the main switch)



**On**  
(power: connect to the main switch)



Move up



Move down



Chinrest



Equipment



Positioning laser  
(Radiation of laser apparatus)



Positions the equipment to start the exposure



**Return**  
Return the device to the home position



**Ready**  
Indicate that the equipment is ready for operation



Radiographic Control



Emission of ionizing radiation



Mandatory action



Refer to instruction manual



General warning



Warning;  
High voltage



Warning;  
Crushing of hands



Warning;  
Ionizing radiation



Warning;  
Risk of entanglement



Do not reuse



Indicates that the product should be taken to a special waste disposal site at the end of its life cycle. Applies to both the device and accessories.









Sterilizable in a steam sterilizer (autoclave) at temperature specified



## **WARNINGS, CAUTIONS AND RECOMMENDATIONS**

## 2. WARNINGS, CAUTIONS AND RECOMMENDATIONS

### General warnings







	<p>Read and understand all instructions contained in these usage instructions before installing or operating this equipment.</p>
	<p>Use only the equipment in perfect conditions and protect yourself, patients and third parties from possible hazards.</p>
	<p>This equipment should be installed and operated by professionals familiar with the necessary precautions in order to avoid excessive exposure to both primary and secondary radiation.</p>
	<p>US Only: Federal law restricts the sale of this device to or on the order of a physician, dentist, or a licensed practitioner.</p>
	<p>The Dental CT Scanner AXR has eight different user interactions:</p> <ul style="list-style-type: none"> <li>- Identification label: Located in the lateral of the equipment;</li> <li>- Security symbology: Located in the places of risks and in its warning label;</li> <li>- Image acquisition software: Found on the pen drive that accompanies the product and will be installed on a computer where the equipment is connected;</li> <li>- Main control panel: located on the chinrest support;</li> <li>- Cephalostat control panel: located in the cephalostat;</li> <li>- Local exposure control: located on the chin rest;</li> <li>- Remote exposure control: located outside the operation area;</li> <li>- Emergency button: located below the chin mounting support.</li> </ul>
	<p>Notice to the user and/or patient: In the case of any serious incident that has occurred in relation to the device, it should be reported to the manufacturer and the competent authority of the Member State in which the user and/or patient is established.</p>

### During transportation

The equipment should be transported and stored, considering the following:

- Handle with care to avoid falls, excessive vibration and impacts;
- The arrows on the packaging should be pointing upwards;
- To handle the package as a single unit considered the center of gravity indicator
- Do not stack above the quantity indicated on the package;
- Do not walk or stand above the package
- Protect from sunlight, moisture, water and dust;
- Comply with the limits of environmental conditions.

### During system installation

	Installation instructions can be found in the service manual, which is only available to authorized technicians.
	The equipment is configured for network voltage during installation of the equipment only by the authorized technician. This is a technical procedure that cannot be performed by the user.
	The equipment must be correctly affixed according to the service manual and must not be subjected to tilting greater than 5°. Risk of tumbling.
	To avoid the risk of electric shock, this equipment must be only connected to a grounded power supply for protection.
	Before connecting the equipment make sure that it is connected to the correct voltage.
	For monophasic installation, fuse F1 must be replaced by the metallic pin provided to eliminate fuse from neutral conductor.

- The equipment should only be installed by authorized service technicians.
- The recommendations of the service manual should be followed in order to ensure the existence of protective earth (ground).
- The recommendations of the service manual should be followed as related to the mandatory existence of a protection circuit breaker.
- The X-ray and the PC should not be connected to a common power supply.
- The PC and any other external devices should not be connected to an extension cable or to an additional multiple portable socket-outlet.
- Install the equipment where it will not be in contact with moisture, water, plants and animals.
- Install the equipment in a location where it will not be damaged by pressure, temperature, direct sunlight, dust, salts or corrosive products.
- This equipment is not intended for use in the presence of vapors of flammable anesthetic mixtures or nitrous oxide neither in oxygen-rich environments.
- Place the computer and any other external devices at least 1.5 meters away from the X-ray unit so that the patient can not touch the computer or any other external device while it is being X-rayed.
- The recommendations in this manual regarding EMC should be followed. Communication equipment and RF-generating sources may affect the operation of the equipment.
- The equipment may cause radio interference or, disrupt the operation of nearby equipment, and it is

necessary to take mitigating measures, such as reorientation, relocation of equipment or site shielding.

- Depending on local regulations, the remote exposure control must be installed in a radiation protected zone by fixed barrier or a screen with protection against X-rays so that the operator is protected during the process of radiographic exposure.
- The remote exposure button should be installed in a radiation protected area location so that the operator has eye contact with the patient. If the situation described above is impossible, a screen with protection against X-rays should be installed so that the operator can be protected by being behind during the radiographic taking.
- The radiological clinic in the Brazilian territory must follow all the sanitary requirements for the organization and operation of diagnostic radiology services, including control of medical, occupational and public exposures resulting from the use of diagnostic radiological technologies in accordance with Directors' Collegiate Resolution RDC No. 611, of 09 March 2022 and Normative Instruction No. 94 of 27 May 2021 on health requirements for quality and safety assurance in extraoral radiology systems or their substitutes. See current legislation.

## **Prior to use of the system**

To help ensure proper hygiene and to protect against infectious diseases, prior to first use, the equipment should be cleaned and disinfected considering the instructions included in this manual

## **During use of the system**

- Under no circumstances the patient is allowed to operate the unit.
- The patient should not touch other parts other than those specific to perform the examination.
- The equipment should only be operated by qualified health professionals with knowledge of precautions against excessive exposure to radiation.
- To operate the unit, the operating personnel must:
  - Have read and understood the user manual
  - Be familiar with the fundamental structure and functions of this unit
  - Be familiar with the emergency situation protocols of this equipment.
  - Be able to recognize irregularities in the functioning of the unit and implement the appropriate measures where necessary.
- The equipment was designed according to the electromagnetic compatibility standards, but in very extreme conditions, it may cause interference with other equipment. Do not use this equipment together with other devices that are highly sensitive to interference or with devices that create high electromagnetic disturbances.
- The equipment is not recommended for display of cartilage structures and soft tissue display.
- Do not position the patient in the unit while it is initiating as the patient could be injured if the equipment malfunctions. In case of an error that requires turn off and back on the equipment, remove the patient before the turn the unit back on.
- During an exposure, the operator should positioning yourself at least 3 meters away from the X-ray unit in order to reduce the amount of ionizing radiation absorbed, maintaining eye contact with the patient and the unit throughout the entire exposure.
- In case of risk to the patient, cancel the exposure immediately by releasing the exposure button or pressing the emergency stop bottom located below the chin mounting support.
- Operators must ask the patient to remain still while the equipment arm is moving.
- If this product is exposed to water, moisture or a foreign substance, immediately turn it off and contact an Alliage Authorized Service Center.
- In case of damage or defect do not use the equipment and contact an Alliage Authorized Service Center.
- Do not use the unit if any of its enclosures or parts are damaged, loose or have been removed. Contact an Alliage Authorized Service Center and ask for the repair or replacement of any damaged, loose or removed unit's enclosures or parts before using the unit again.
- Do not touch the unit or use it if it is being repaired or the unit's enclosures have been removed.

## Owner's Manual

---

- Do not open or remove any of the unit's enclosures. No user serviceable parts inside.
- In case of fall or impact of moving parts causing their breakage, care in handling them, there may have sharp parts.

### Protection against radiation



Protection measures against ionizing radiation should be taken to avoid collateral effects to users and operators.



The lead apron and thyroid collar are not provided with the equipment.

- Exposure to X-rays can cause damage to the cells of the human body.
- Radiation protection equipment should be used in order to reduce radiation exposure to the patient, specifically for pediatric and pregnant patients.
- The patient must use lead apron and thyroid collar during the exposures.
- The use of X-ray equipment in pregnant women is not recommended without medical authorization.
- It is not recommended for use in people with involuntary muscle spasms in the neck and head or Parkinson's disease.
- Patient with cardiac pacemaker or an implantable cardioverter defibrillator (ICD) must consult its manufacturer before taking an exposure to confirm that the x-ray unit will not interfere with its operation.
- No one should remain in the room during an exhibition, unless the patient needs to be restrained. In this case, a third person should be adequately protected against the emission of ionizing radiation.
- During an exposure, the operator should position himself as far as possible from the focus of the X-ray generator, maintaining a minimum distance of 3m or placing himself behind a physical barrier, to minimize the amount of ionizing radiation absorbed.

### Cross-contamination prevention



Adequate cleaning and disinfection/sterilization measures should be taken to avoid cross-contamination between patients, users and others.

- To help prevent cross-contamination among patients, use of disposable protective plastic covers is mandatory. The protective plastic cover should preferably cover non-sterilizable items as the nose support and ear rods.
- For each new patient, plastic covers should be disposed of properly.
- Never use damaged plastic protective covers.
- For each new patient, perform the cleaning, disinfection/sterilization procedures and according to the instructions contained in this manual.

### After using / operating the system

- Turn off the equipment if it is not in use for a long time.
- Protective plastic covers should be discarded and all parts that have been in contact with the patient should be cleaned and disinfected/ sterilized with each new patient in order to avoid

transmission of infectious agents that may cause serious illnesses.

- Perform cleaning, disinfection/sterilization in compliance with the instructions indicated in the present manual.
- Do not disconnect the cable or other connections unnecessarily.
- Do not modify any part of the equipment or system.

### Precautions in case of change in equipment operation

If the equipment is subject to any abnormality, check whether the problem is related to an item listed in the "Troubleshooting" section of the present user manual.

If the problem cannot be solved, turn off the power, disconnect the cables, and contact an Alliage Authorized Service Center



The manufacturer CANNOT be held responsible for:

- If the equipment is used for purposes other than those for which it was designed.
- Damages caused to the equipment, operator and / or patient, as a result of improper installation and maintenance procedures not in compliance with the operating instructions provided with the equipment.
- Inadequate operation of equipment

### Precautions for reducing environmental impact

Alliage S/A aims to achieve an environmental policy to promote supply of environmentally conscious medical and dental products that continuously minimize environmental impact and that are friendlier to the environment and human health.

To maintain a minimal impact to the environment, consider the recommendations below:

- After installation, send the recyclable materials to the recycling process.
- During the life cycle of the equipment, turn it off when not in use.
- To prevent environmental contamination, the disposal of plastic protective covers and other consumables should follow the normal procedure for biomedical waste.

Biomedical waste shall include non-acute materials which may cause diseases or suspicions of sheltering pathogenic organisms which should be stored in a yellow bag, duly labeled with a biohazard symbol, stored in a leak-tight, watertight container until collection and incineration.



Packages of the Dental CT Scanner AXR are made of wood, cardboard, plastic and expanded polystyrene (EPS) which are 100% recyclable materials.

#### DIMENSIONS:

Main Unit: 1711 X 586 X 1318 //MASS: Approximately: 49.3 Kg

Cephalostat: 1105 X 665 X 963mm /MASS: Approximately: 24 Kg

Base: 1215 X 770 X 300mm /MASS: Approximately: 50 Kg

### Precautions in case of non-use of the equipment

To avoid environmental contamination or misuse of the Dental CT Scanner AXR, when it is not in use, it should be discarded (according to the legislation in force) in an appropriate location, as the material inside may contaminate the environment.

For the European Economic Area (EEA), this product is subject to Directive 2012/19/EU, as well as to the corresponding national laws. This directive requires the product to be taken to a special garbage collection site at the end of its life cycle. Applies to both device and accessories  
Contact your dealer if the final product disposal is required.



This equipment should not be disposed of as household waste.

# 3

## SYSTEM GENERAL DESCRIPTION



### 3.SYSTEM GENERAL DESCRIPTION

#### 3.1.DESCRPTION OF SYSTEM

The Dental CT Scanner AXR is a complete 4-in-1 dental imaging system capable of generating panoramic, cephalometric and tomographic images using cone beam computerized tomography technique (Cone Beam).

The digital acquisition process utilizes an X-ray sensor and automatic image processing that allow you to increase the speed of diagnosis and improve the workflow of your clinic.

All models have three-axis movement (two orthogonal directions and one rotation) making it possible to perform images in multiple radiographic programs, consisting of complex movements around the dental arch and compensation of radiological emissions in the vertebral region, when necessary reconstructs the dental arcade into a flat image

Each individual program prioritizes a set of characteristics to improve diagnostic capabilities. For example, the panoramic pattern prioritizes the width of the image layer, constant vertical magnification, and homogeneous exposure throughout the entire image. Low dosage prioritizes dose reduction (time and anodic current).

The programs can be applied to a variety of patients and have predefined exposure parameters, depending on the type of patient. Providing the operator the freedom to change these parameters depending on the situation.

Multi Slice configurations have a function allows the reconstruction of the panoramic exam in various slice layer positions, so that the user can select the focus on specific anatomical structures depending on their needs. The Multi Slice function allows the user to adjust the position of the flattened arch image on the image cutting plane. To better explain, for dental panoramic image, the cutting plane is a region in which the structures positioned in it are reasonably well defined in the final image. In a conventional software, the equipment generate only one Slice of the panoramic image in the most favorable theoretical position in the cutting plane. In that case, image definition will depend on the patient being physically positioned on the equipment as close as possible to this ideal position. With the Multi Slice function, the software generates multiple images varying the ideal theoretical position. Thus, even if the patient is poorly positioned, it is possible to find the position where the image is best defined for the exam. Thus, by virtually moving the patient's ideal position, we can seek the best-defined image in the final image for each exam.

The man-machine interface of the equipment consists of a control panel located near the patient's chin support, a local exposure button, a remote exposure button, and desktop software. Exposure buttons are a type shutter button that if released stops the exposure.

The device is equipped with nine lasers for positioning: Sagittal Medium Plan, Frankfurt Plan and Layered Image Plan (canine), which makes it possible for the user to accurately position the patient. For patient comfort, a demonstration mode is also available making it possible to demonstrate movement of the equipment without X-ray exposure.

## 3.2.MAIN COMPONENTS OF THE PRODUCT

### 3.2.1.Panoramic only

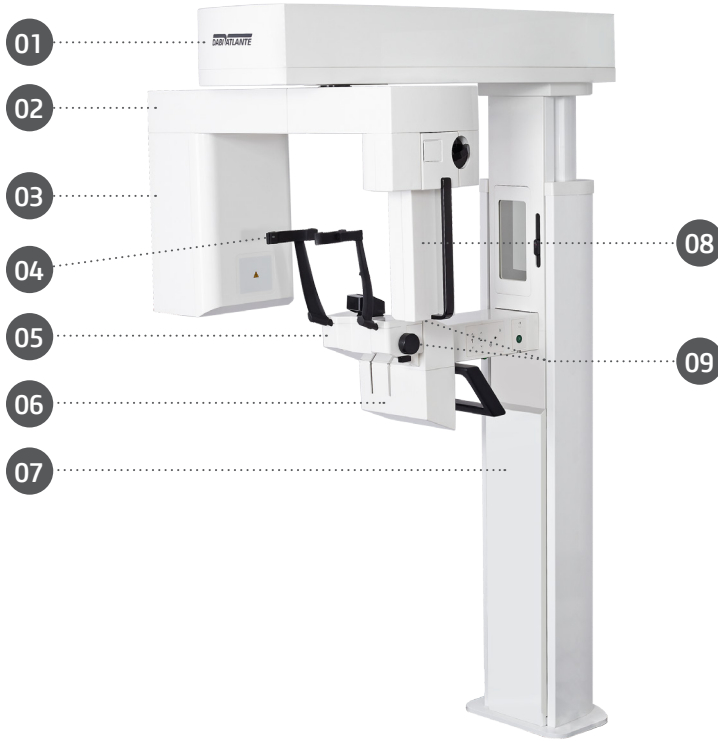

- 01 - Movement mechanism
- 02 - Rotation Arm
- 03 - X-ray tube assembly
- 04 - Head support
- 05 - Chin support
- 06 - Handle for patient
- 07 - Column
- 08 - 2D Digital Sensor
- 09 - Laser Positioning Buttons

### 3.2.2.Panoramic with Cephalostat



- 01 - Movement mechanism
- 02 - Rotation Arm
- 03 - X-ray tube assembly
- 04 - Head support
- 05 - Chinrest support
- 06 - Handle for patient
- 07 - Column
- 08 - 2D Digital Sensor
- 09 - Cephalostat arm
- 10 - Cephalostat
- 11 - Secondary Collimator
- 12 - Ear rods Support
- 13 - Sensor Support



Available in configuration with single mobile digital sensor or two fixed digital sensors.

### 3.2.3.Panoramic Mult Slice

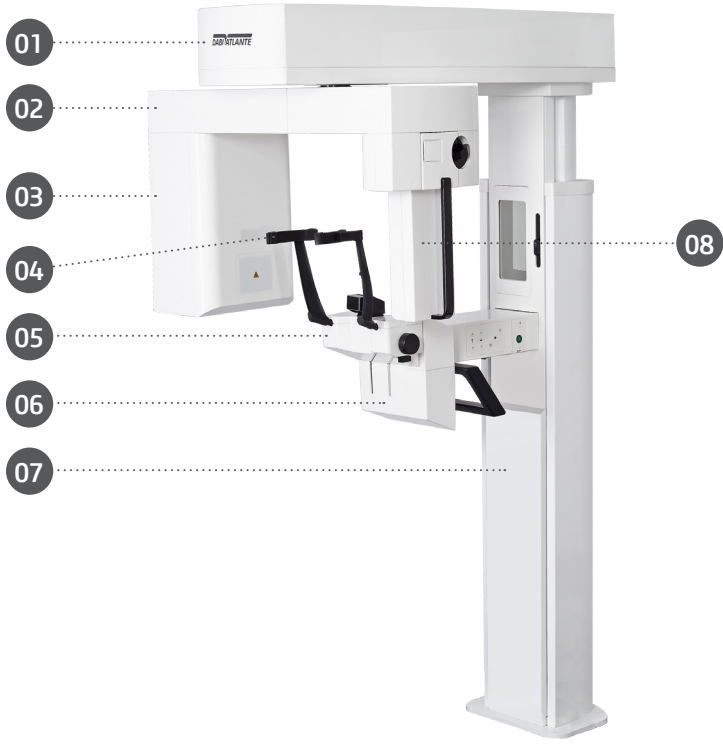

- 01 - Movement mechanism
- 02 - Rotation Arm
- 03 - X-ray tube assembly
- 04 - Head support
- 05 - Chin support
- 06 - Handle for patient
- 07 - Column
- 08 - 2D Digital Sensor

### 3.2.4. Panoramic Mult Slice with Cephalostat



- 01 - Movement mechanism
- 02 - Rotation Arm
- 03 - X-ray tube assembly
- 04 - Head support
- 05 - Chinrest support
- 06 - Handle for patient
- 07 - Column
- 08 - 2D Digital Sensor
- 09 - Cephalostat arm
- 10 - Cephalostat
- 11 - Secondary Collimator
- 12 - Ear rods Support
- 13 - Sensor Support



Available in configuration with single mobile digital sensor or two fixed digital sensors.

### 3.2.5. Tomography only

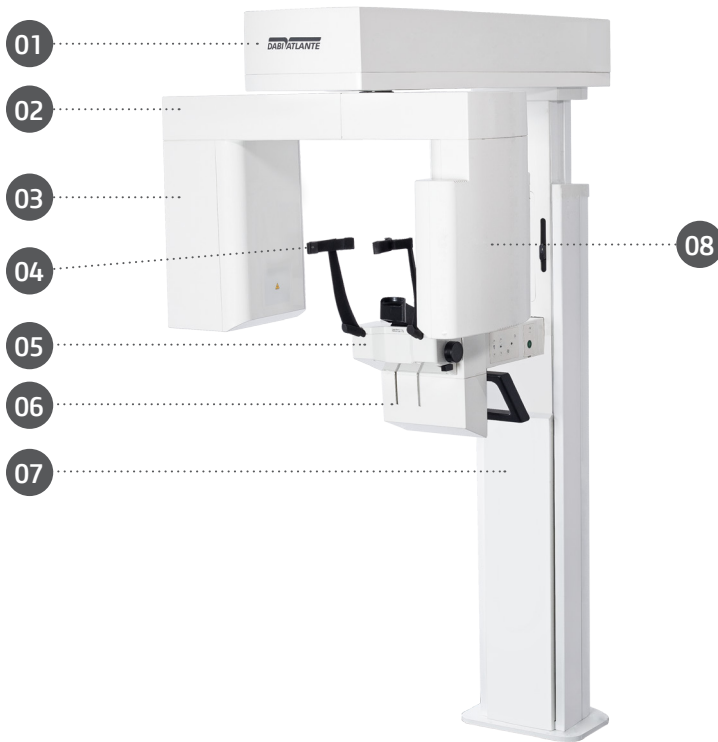

- 01 - Movement mechanism
- 02 - Rotation Arm
- 03 - X-ray tube assembly
- 04 - Head support
- 05 - Chinrest support
- 06 - Handle for patient
- 07 - Column
- 08 - Panoramic / Tomographic Sensor

### 3.2.6. Tomography with Cephalostat

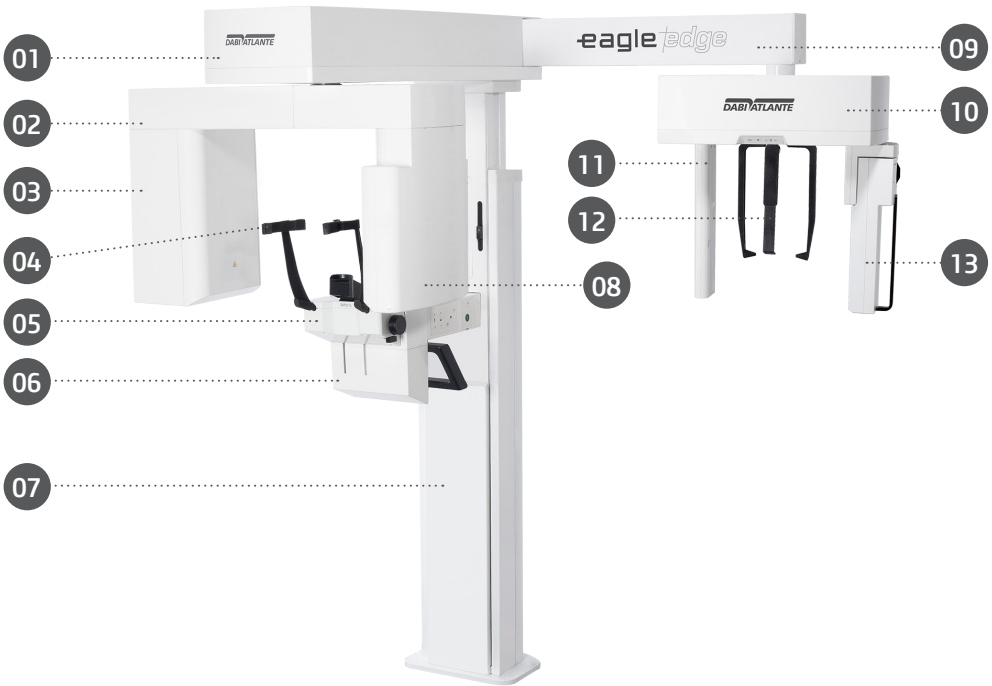

- 01 - Movement mechanism
- 02 - Rotation Arm
- 03 - X-ray tube assembly
- 04 - Head support
- 05 - Chin mounting support
- 06 - Handle for patient
- 07 - Column
- 08 - Panoramic / Tomographic Sensor
- 09 - Cephalostat arm
- 10 - Cephalostat
- 11 - Secondary Collimator
- 12 - Ear rods Support
- 13 - 2D Digital Sensor

### 3.2.7. Tomography 0.2FS \*

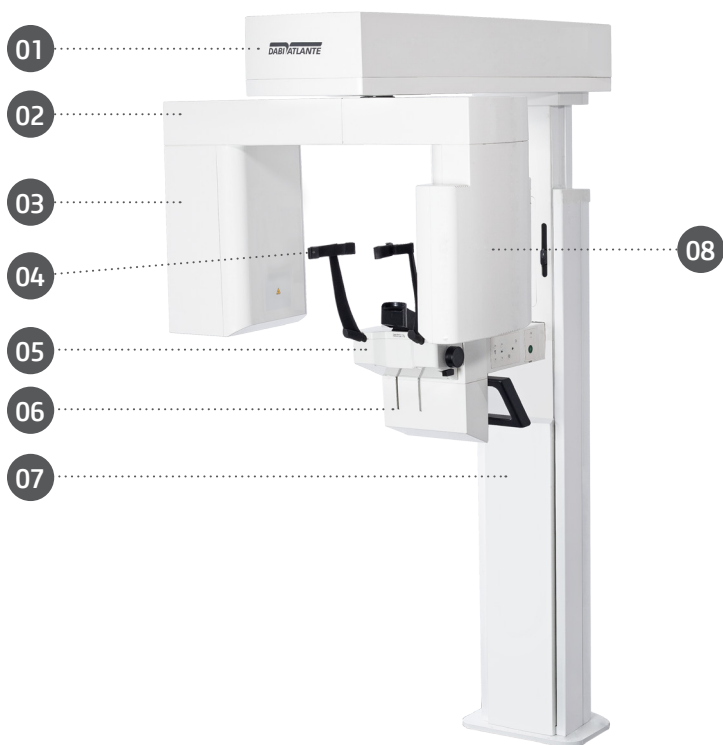

- 01 - Movement mechanism
- 02 - Rotation Arm
- 03 - X-ray tube assembly
- 04 - Head support
- 05 - Chin mounting support
- 06 - Handle for patient
- 07 - Column
- 08 - Tomographic Sensor

---

\* Exclusive configuration for the AXR90 model



### 3.3.SETS AND ACCESSORIES



All parts, accessories and options described in the owner's manual are for exclusive use only. Use of any parts, accessories or material not specified in this owner's manual is the sole responsibility of the user

### Accessories that accompanied the product



Accessories Class I sell with the product.

#### 3.3.1.Positioners Kit

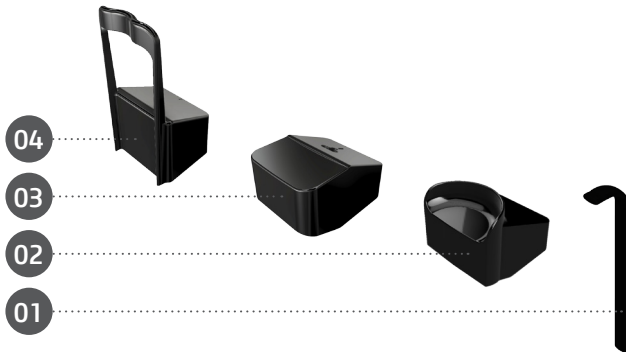

The Positioners Kit is composed by:

- 01 - Biteguide (5 units)
- 02 - Panoramic Chinrest for edentulous patient/ 3D positioner (1 unit)
- 03 - Panoramic Chinrest for panoramic for toothed patient (1 unit)
- 04 - TMJ / Maxillary Sinus positioner (1 unit)

#### 3.3.2.Carpal support kit

The Carpal Support kit is composed by:

- 01 - Carpal Support (1 unit)



## Optional accessories

### 3.3.3. Free standing base

The following image shows the free standing base options that can be used in all configurations.

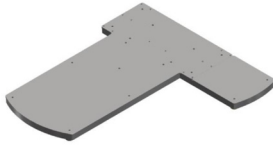

"T" Base

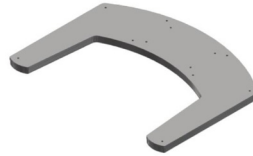

"U" Base

### 3.3.4. QA kit

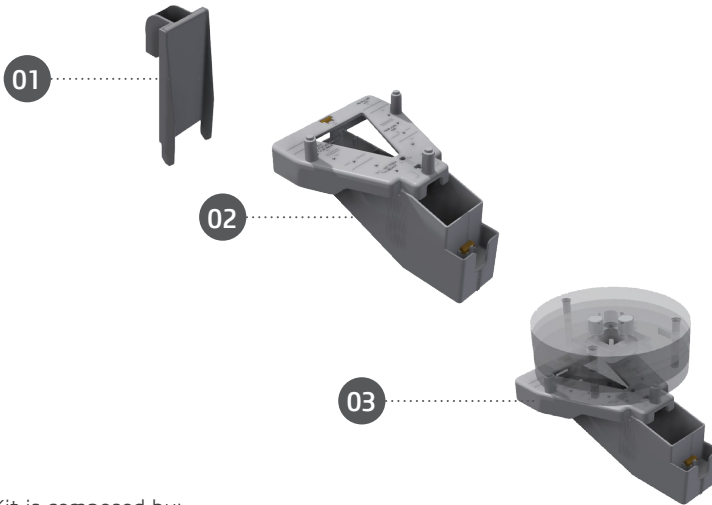



The QA Kit is composed by:  
1 - Resolution test device (1 unit)  
2 - QA device for Panoramic (1 unit)  
3 - QA device for Tomographic (1 unit)

## Accessories not provided with the product

### 3.3.5. Hygienic protective covers



	Hygienic protective covers are not provided with the product.
---	---

<p>Rx only</p> 	<p>When purchasing a Hygienic protective covers, always follow the items listed below:</p> <ul style="list-style-type: none"><li>• Always use Hygienic protective covers made of non-cytotoxic, non-irritating and non-sensitizing polyethylene material in accordance with ISO 10993-1.</li><li>• Always use products for dental use only.</li><li>• Always discard after use. Do not re-use.</li></ul>
--	--

### 3.3.6. Prosthesis support

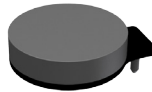

	The prosthesis support is not included with the product. The manufacturer provides the file in STL format for 3D printing.
---	--

### 3.4.APPLIED PARTS

The following items are used when positioning of the patient in the equipment.

Part's Type		Contact Type	Duration of contact
Biteguide	Detachable	Teeth/mucosal membrane/ skin	<60s
Panoramic Chinrest for panoramic for toothed patient	Detachable	Skin	<60s
Panoramic Chin rest for edentulous patient/ 3D positioner	Detachable	Skin	<60s
TMJ / Maxillary Sinus positioner	Detachable	Skin	<60s
Carpal Support	Detachable	Skin	<30s
Handle	Fixed	Skin	<60s
Ear rods	Fixed	Skin/outer ear/ external auditory canal	<30s
Head support	Fixed	Skin	<60s
Seat upholstery*	Fixed	Skin	<60s
Nasal support	Fixed	Skin	<30s
Hygienic protective covers*	Consumable	Teeth/mucosal membrane/ skin/ outer ear/ external auditory canal	<60s

\* Not provided with the product.

\*\* Covers panels, column, cephalostat arm, chin mounting support and base may enter in superficial contact with the patient (<10s), but do not fit into the applied parts.

### 3.5.USER CONTROL INTERFACE

#### 3.5.1.Main control panel

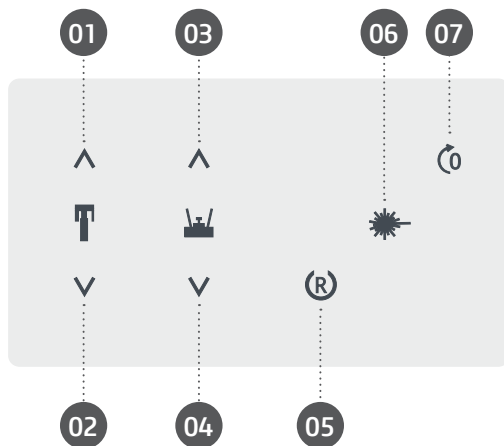

Buttons	Function
1 - Unit up	Move the unit up to the desired position
2 - Unit down	Move the unit down to the desired position
3 - Chinrest Up	Move the chinrest up to the desired position
4 - Chinrest Down	Move the chinrest down to the desired position
5 - Ready to Expose position	Positions the equipment to start the exposure
6 - Laser	Turns the positioning laser on or off
7 - Patient Entry or Exit Position	Positions the equipment to the patient entry or exit position

### 3.5.2.Cephalostat control panel

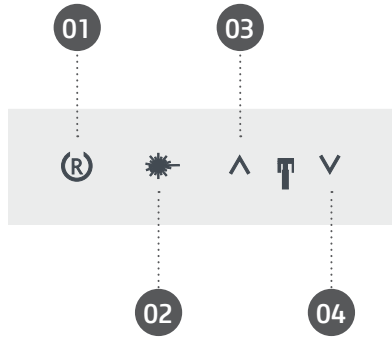

Buttons	Function
1 - Return	Returns the equipment to the initial position
2 - Laser	Turns the positioning laser on or off
3 - Unit up	Move the unit up to the desired position
4 - Unit down	Move the unit down to the desired position

### 3.5.3.Local and remote exposure control

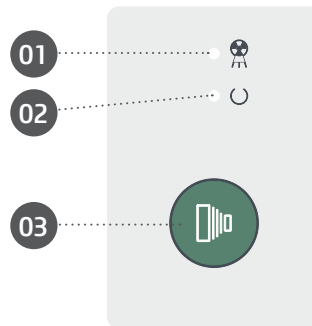

Buttons / Indicators	Function
1 - Yellow LED	Emission of ionizing radiation
2 - Green LED	Indicates that the equipment is ready to obtain an exposition
3 - Exposure button	Trigger

### 3.5.4. Emergency stop button

The equipment has an emergency stop button located on the lower part of the chin mounting support.

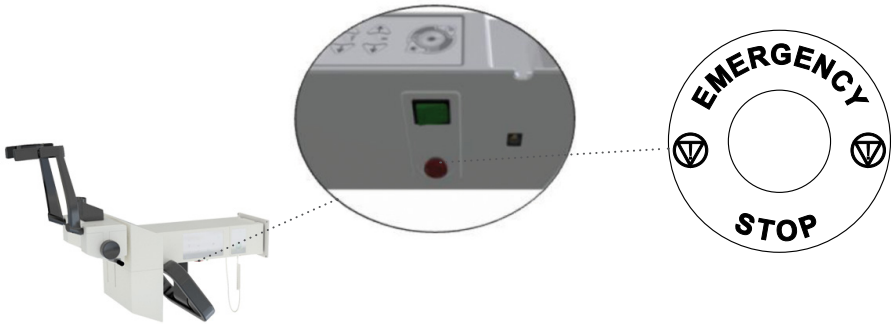

The emergency button, when pressed, interrupts the entire operation of the equipment, including movement and emission of X-rays. After the emergency button is pressed, it will be locked until its release by the operator. To release the emergency button and resume the equipment operation, turn the emergency button counterclockwise, following the markings on the button.

### 3.6. LABEL POSITIONING

The following figure illustrates the location of the labels on the equipment.

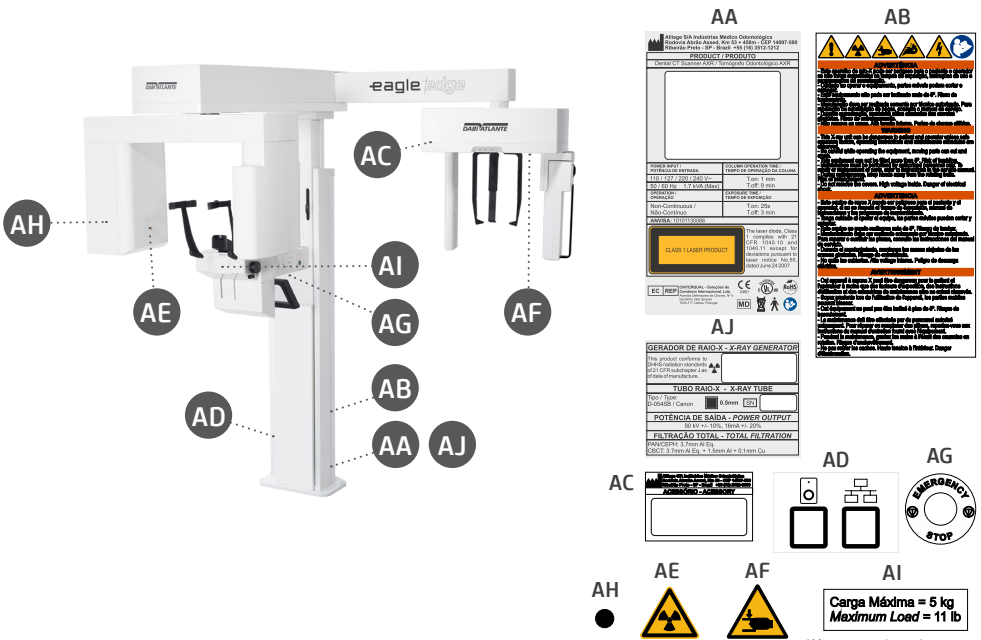

<b>AA</b>	<b>AB</b>
<b>AJ</b>	
<b>AC</b>	<b>AD</b>
<b>AH</b>	<b>AE</b>
	<b>AF</b>
	<b>AI</b>
	<div style="border: 1px solid black; padding: 5px; display: inline-block;">                 Carga Máxima = 5 kg                  Maximum Load = 11 lb             </div>

illustrative image

## 3.7.SYSTEM REQUIREMENTS

### 3.7.1.Software requirements

For the correct operation of the equipment capture software, some basic software is required which are described below:

Microsoft® .Net Framework 4.5.1: The .NET Framework is essential for running many programs that were developed using Microsoft technology. This framework provides a number of features for agile and robust application development. Version 4.5.1 requires Windows Vista SP2 and above and is included with Windows 8.1 and Windows Server 2012 R2.

Microsoft® Visual C++ 2013 (MSVC): Is a Microsoft integrated development environment (IDE) product for C, C ++ and C ++ / CLI programming languages. It has tools to develop and debug C ++ code, especially written code for Windows API, DirectX and .NET Framework.

Java Runtime Environment 8.0: The Java Runtime Environment (JRE) is a set of software tools for development of Java applications. It combines the Java Virtual Machine (JVM), platform core classes and supporting libraries.

PostgreSQL 10: PostgreSQL is an open source relational database management system (DBMS) developed by a worldwide team of volunteers. PostgreSQL is not controlled by any corporation or other private entity and the source code is available free of charge.

eBUS™ release 4.1.5: eBus release software 4.1.5 offers proven tools for acquisition, control and processing and field analysis to design, develop and deploy high-performance machine vision applications.

The software required to run the software will be automatically installed as a prerequisite during the installation of the application, giving the user greater speed, security and convenience.





## 3.7.2. Hardware requirements

It is necessary that this computer system is of EXCLUSIVE USE for the equipment and that it MUST meet the following requirements.

Computer specifications		
	2D	3D
Operational system	Windows 10 Professional – 64 bit	Windows 10 Professional – 64 bit
CPU	Intel® Core™ i5 Gen 10 Cache 12MB 4.0 GHz or superior	Intel® Core™ i7 Gen 10 Cache 12MB 4.0 GHz or superior
Video card	-	NVidia Geforce GTX 1060 6GB or superior  Recommended for faster rebuilds: NVidia GeForce RTX 2060 6GB or superior
Power supply	400W or superior*	500W or superior*
HDD	1 TB	1 TB
RAM	8 GB	16 GB
PCI	PCI Express (PCIe)	PCI Express (PCIe)
Dedicated network card	Gigabit Ethernet (1000Mb/s), JumboPacket 9KB (Intel i350-T1, Intel Gigabit CT, PCE-1G-01-LP)	Gigabit Ethernet (1000Mb/s), JumboPacket 9KB (Intel i350-T1, Intel Gigabit CT, PCE-1G-01-LP)
Monitor	Resolution 1920x1080	Resolution 1920x1080

\* Compatible PCI Express add-in video card connectors.

	<p>The computer must be approved by CE and must be in conformity with the standard EC 60950-1:2005 + AMD1:2009+AMD2:2013 and the Low Voltage 2014/35/EU and the EMC 2014/30/EU Directives.</p> <p>In addition, to help ensure optimum performance, make sure that all installed programs are virus-free and have been properly tested so that you do not influence the image acquisition software after installation.</p>
---	---

	<p>It is recommended to perform periodic backups on patient files and data to avoid loss of history in the event of a computer system failure.</p>
---	--

### 3.7.3. Location of installation



To meet the safety regulations, don't operate non-medical equipment like personal computers inside the patient area. Outside the patient area, it's acceptable the presence of non-medical equipment as long as it's used computer equipment approved and certified.

The computer equipments must be approved by CE and must be in conformity with the standard EC 60950-1:2005 + AMD1:2009+AMD2:2013 and the Low Voltage 2014/35/EU and the EMC 2014/30/EU Directives

Position your computer and video monitor out of the patient's area, making sure there is sufficient space for positioning and proper ventilation.

Use monitors preferably with 5:4 aspect ratio, 178° viewing angle and Full HD resolution. Position the screen to avoid direct light or reflections that may cause difficult viewing of images.

The equipment must be at least 1.5 meters from the computer. Only medical equipment may be in the patient's area.

### 3.8.SYSTEM LAYOUT

The electromedical system consists of the tomograph and the computer.

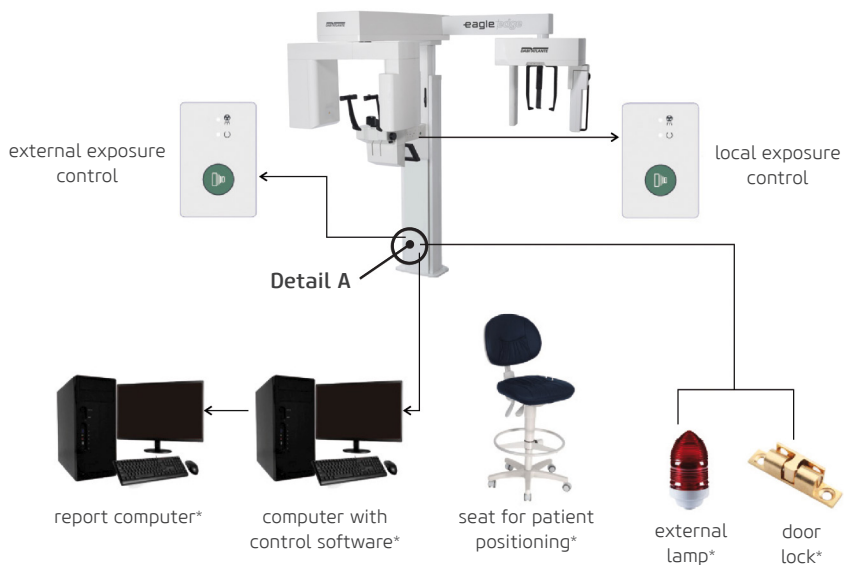

\*Do not accompany the product

The equipment is connected to the computer via the data cable and to the remote exposure control via the ethernet cable. In order to avoid incorrect connection of ethernet cables and data to the equipment, the connection must be made according to the marking on the label located on the lower right side of the equipment column:

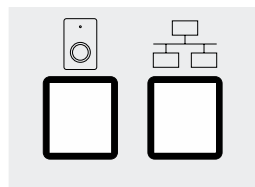

Detail A



Connecting other equipment to the ethernet connector, except the computer specified in this manual, is not allowed.

# 4

## OPERATION

## 4. OPERATION

### 4.1. INITIAL PREPARATION



The equipment should be cleaned and disinfected prior to use in a new patient, following the instructions in this manual.



To isolate the equipment from the electric power network, use the general switch.



The lasers used in the equipment are Class I lasers which indicates that the output power is minimal. However, as a good practice, intentionally avoid exposing the laser beam directly to the eyes of the operator and patient.

The nose support and ear rods support must be fitted with the hygienic protective covers to make sure it will not come in direct contact with the patient.

To turn the equipment on or off use the general switch located under the chin mounting support.

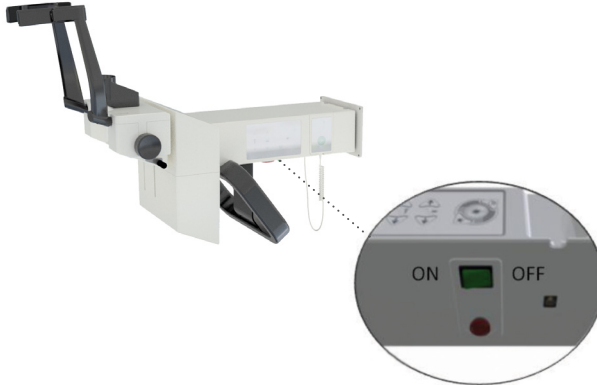

When the general switch is activated, the microprocessor controls of the Dental CT Scanner AXR verify the entire system, and if it is in compliance with the specifications, the green LED on the exposure button will indicate that it is ready for exposure.

## 4.2.SNAP SENSOR



Handle the sensor carefully according to the instructions in this manual. Do not drop the sensor or expose it to impact.

### Attaching the sensor

1. Insert the two holes on the back of the sensor into the two pins of the sensor holder.

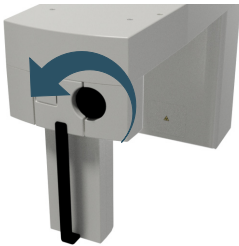

2. Turn the split button 180 ° counterclockwise.

3. Press the button on the back of the sensor holder to lock.



### Removing the sensor

1. Press the right side of the split button to unlock the sensor and turn the knob 180 ° clockwise.

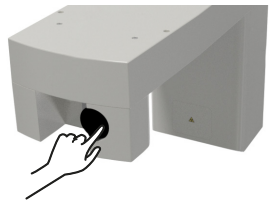

2. Pull the sensor away

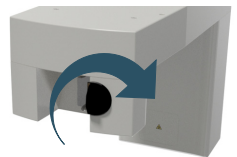

## 4.3. PATIENT REGISTRATION

### Login

Double-click on the software icon on the Desktop.



Log in with your username and password.

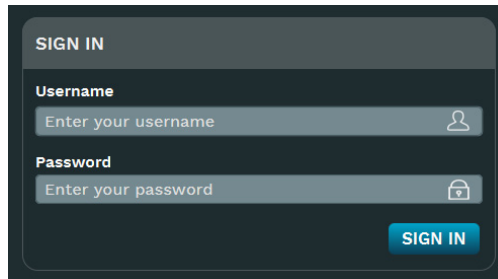

### Initial screen

To perform the image capture you will need to register a new patient or select a previously registered patient.

The Home stage is the first window the software displays after the login. It contains some options to the user start a task quickly.

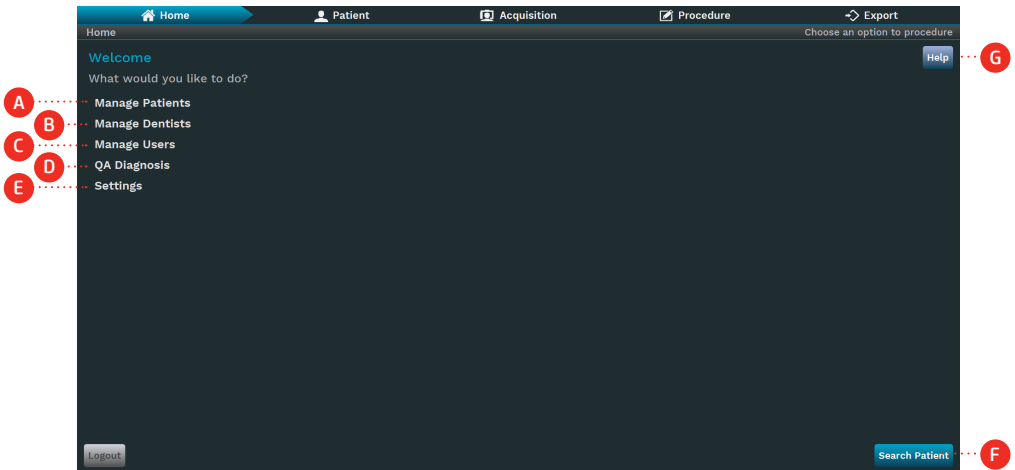

### Description

- A. Manage Patients: Click to choose between creating or searching patients.
- B. Manage Dentists: Click to choose between creating or searching dentists.
- C. Manage Users: Click to choose between creating or searching users.
- D. QA Diagnostics: Click to configure the QA diagnostic test.

- E. Settings: Go to settings screen.
- F. Search Patient: Go to search patient window.
- G. Help: Open user manual.

## Patient stage

To perform the image capture, it is necessary to register a new patient or select a previously registered patient.

To enter the patient stage, click “Patient” on the workflow bar or on the Home stage. The software will display the following window.

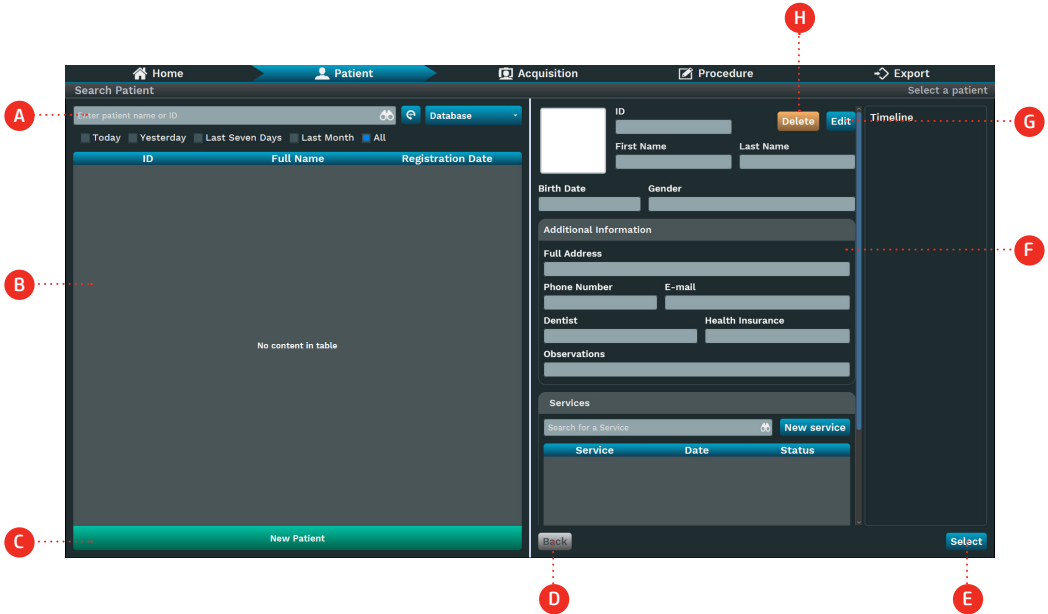

In this stage, the user can manage the patients including adding, searching, updating and deleting them.

## Description

- A. Patient Search Bar: Filter and search the patients by his/her ID or name.
- B. Patient List: Display the last patients created or according to filter applied to Patient Search Bar.
- C. Add New Patient: Click to add a new patient.
- D. Back: Return to Home stage.
- E. Select: Select the patient and go to his/her exams window.
- F. Patient Information: Show the information of the patient selected on the list.
- G. Edit: Click to edit the selected patient.
- H. Delete: Click to delete the selected patient.



## New patient

Click on New patient.

Describe the patient data in the fields mentioned below.

The screenshot shows the 'New Patient' form with the following fields and callouts:

- A:** Patient photo
- B:** ID\*
- C:** First Name\*
- D:** Last Name\*
- E:** Birth Date\*
- F:** Gender\*
- G:** Health Insurance
- H:** Confirm button
- I:** Back button

The form includes sections for 'Additional Information' (Zip Code, Full Address, Phone Number, Cell Phone, E-mail, Dentist, Observations) and 'Services' (Standard Panoramic, ATM Panoramic, ATM PA Panoramic, Child Panoramic).

## Description

A. Patient photo: Import the photo from the disk or take a photo using a webcam.

B. ID: Enter the ID. Required Field

C. First name: Enter the first name. Required Field

D. Last name: Enter the last name. Required Field

E. Birthdate: Enter the birthdate Required Field

F. Gender: Choose the gender Male or Female. Required Field

G. Additional informations (optional):

- Postal code
- Dentist: Search or add it from the database
- Full address
- Phone number
- Mobile number
- Health Insurance
- Observations

H. Confirm: Create the patient on the database.

I. Back: Return to the previous window

After filling in the patient data, click on Confirm.

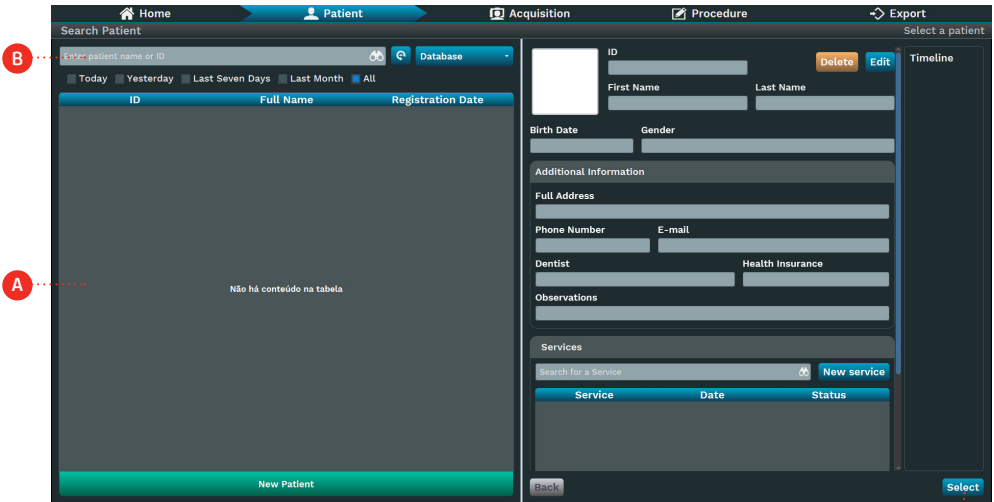

## Search patient

The software will open the patient search screen; select the patient from the list of registered patients (A) or type ID or the patient name in the search field (B).



Identify the patient on the list and click on his/her name. After that, click on Select (C).

## 4.4.PATIENT PREPARATION

	<p>Ask the patient to remove any objects such as glasses, hearing aids, prosthetics and personal jewelry, such as earrings, necklaces and hair clips, etc.</p> <div style="text-align: center;">  </div> <p>Ask the patient to wear protective lead apron and thyroid collar, especially for pediatric patients, according to local regulations</p> <div style="text-align: center;">  </div>
---	---



To prevent cross-contamination, use hygienic covers that should be discarded after usage on each new patient, always observing if they are not damaged.

### 4.5.PANORAMIC EXAM

#### Preparation

There are three different types of support that can be used depending on the type of examination to be performed as noted in the figure below.



Chinrest for  
toothed patient



Biteguide



Chinrest for  
edentulous  
patient



TMJ / MS  
Positioner

The first is used for patients with teeth and it has two parts (biteguide and chinrest). The second is used for patients without teeth. This support don't need biteguide. The third is used for any type of patient only for the ATM and Maxillary Sinus programs. Select the appropriate support for the examination you wish to perform and insert it into the support of the support according to the example.



Before positioning the patient, fully open the temple support by rotating the side knob.

## Patient positioning

### A) Panoramic exams

After the patient has been prepared, ask them to go to the main unit of the equipment. The patient should be positioned upright. If necessary, the patient could be positioned seated. Adjust the height of the equipment using the main control panel.



The height adjustment movement starts slowly and then increases its speed. A patient positioned in the unit may be injured by moving parts. Monitor the patient and the movement of the unit during height adjustment.

For toothed patients, ask to lean on the chinrest and bite the biteguide. The incisal edges of the maxillary and mandibular teeth should be in the gap of the biteguide. Afterwards, ask them to hold on to patient support.

For edentulous patients, use the specific chinrest for this patient and ask the patient to lean the chin against it.

If minor height corrections are required, press and release quickly the respective keys on the main panel.

Open the mirror on the column to begin positioning the patient.



Press the Laser key to turn on the positioning lasers in order to position the patient. The lasers automatically shut down after a period of time, or if the exposure button is pressed. If the lasers turn off before the patient is positioned, press the Laser button again to restart them.

Use the lasers to position the Mid-Sagittal plan, the Frankfurt plane, and adjust the image layer.

The Frankfurt plane laser is located in the column and the operator can move it and adjust its position manually.



## Owner's Manual

---

The laser must pass through the porion and patient's orbit. If necessary, adjust the inclination of the patient's head.

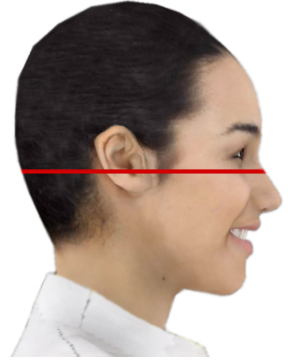

The Mid-Sagittal Plane laser assists the operator to check that the patient's head is not tilted or turned to the side. If necessary, adjust the inclination of the patient's head.

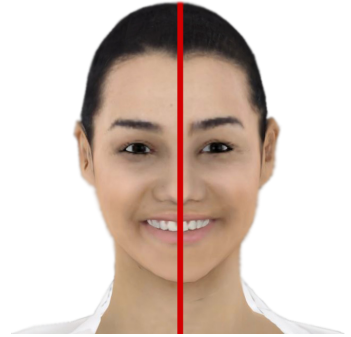

The image layer laser is located on the chin rest and the operator can move it and adjust its position manually.

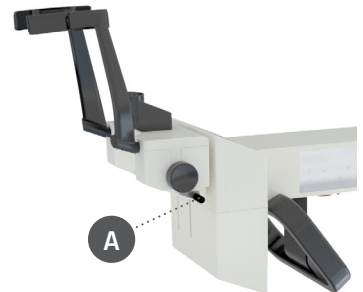

Position the laser in the middle of the upper canines (or at the base of the nose, if edentulous) to help program the image layer.

When finished positioning, close the column mirror.  
Press the Ready button on the control panel to position the equipment in its capture position.

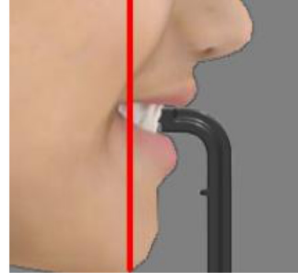

## B) TMJ and maxillary sinus exams

For the Maxillary Sinus and TMJ programs it will be necessary to use the TMJ/MS positioner.  
Ask the patient to support the top of the nose against the positioner.

For TMJ examination it will be performed two exposures one with the patient with the mouth closed and other with mouth open.

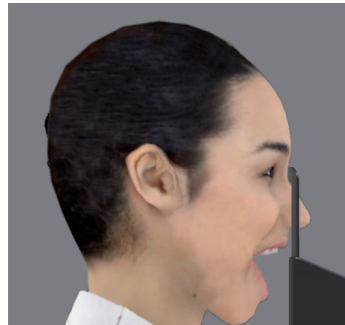
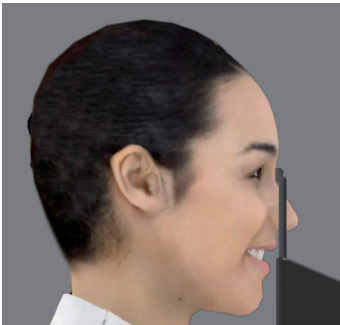

## Acquisition software - Panoramic

After selecting a patient and clicking the Select icon, the software will display the capture screen.

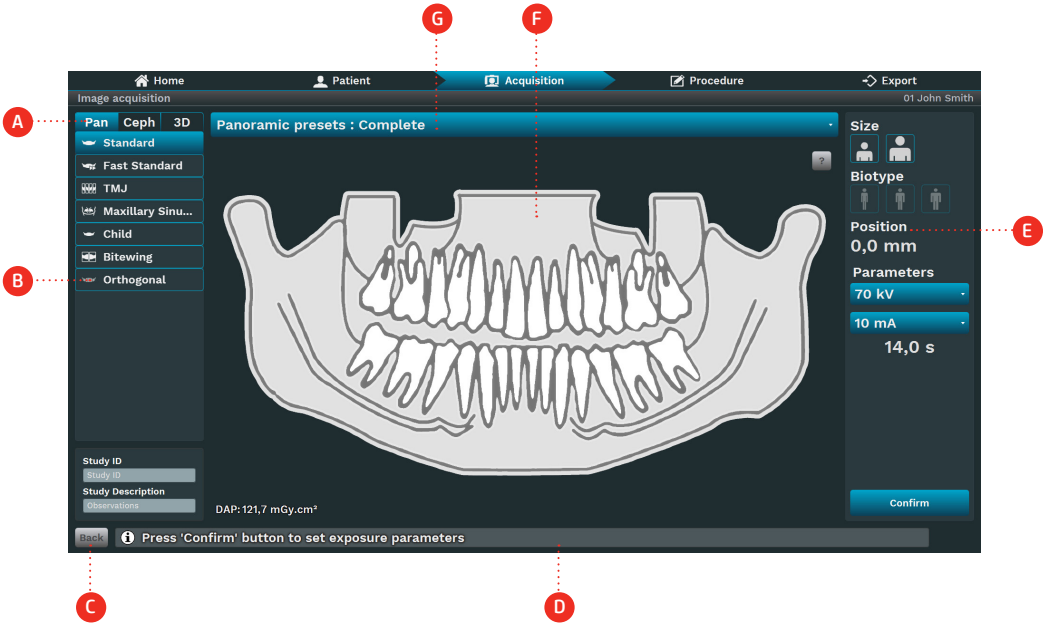

### Description

- A. Exam type: Choose among Pan, Ceph 3D or Scan exams options depending on the equipment model.
- B. Program type: Choose among the programs according to the exam type. The programs are enabled according to equipment model.
- C. Back: Return to previous window
- D. Status Bar: Display the state of the equipment with operating messages.
- E. Exposure parameters:
  - Size: Child or Adult
  - Biotype: Small, Medium or Large
  - Kv Value
  - mA value
  - Time: Exposure time in seconds
  - Canine position: Position of canine laser in millimeters
- F. Profile drawing: View a profile drawing according to the profile type.
- G. Profile Region: Click to choose the profile region:
  - Complete
  - Left segment
  - Central segment
  - Right segment

On tab of exam type selection (A), click PAN.

Select the program to be performed (B). The selected program will be shown in the center area of the image.

Then select the exposure parameters (E).

If patient size and biotype are selected, the software will indicate KV and mA values, which are only starting points to be replaced by more specific user-developed protocols. The operator can manually adjust the value of KV and mA.

Note that the status bar (D) indicates Ready to Exposure.



The acquisition software will wait for the x-ray emission on the sensor to start the acquisition.

Inform the patient of all movements that the equipment will perform.

Ask the patient to swallow, position the tongue in the roof of the mouth, breathe normally, and do not move during the examination.

Position yourself to a protected area without losing direct patient eye contact.

If the patient moves, stop the operation immediately by releasing the exposure button. If the exposure button is released during the radiographic examination, the emission and movement of the equipment will be interrupted immediately.

	Maintain visual and audible contact with the patient and the equipment throughout the radiography process. If the radiography or movement stops during the process due to an internal equipment error, release the button immediately and assist the patient to exit the equipment.
	Never leave the patient unattended during the acquisition procedure.
	The force of movement, even when it collides with the patient, is not enough to cause any harm, even in children.

Press and firmly hold the exposure button. During exposure a visible LED and a continuous audible signal will indicate the emission of X-rays.

A sound of two long beeps will indicate the end of the emission.

If the operator interrupts the exposure the device will emit a sound of three short beeps.

If the exposure is interrupted by the equipment, it will emit a sound of five short beeps.

After the end of the x-ray exposure, the exposure button can be released and the equipment will move to the patient's exit position. At this point, you can guide the patient out of the equipment.

After a few seconds the rotation arm will return to the initial position for the next patient.



### TMJ Program

The TMJ Program performs a double exposure.

After the patient has been prepared, ask them go to the main unit of the equipment.

The patient should be positioned in the standing unit. If necessary, sitting positioning is also possible. Adjust the height of the equipment using the main control panel.

Ask the patient to lean the top of the nose on the TJM/MS chinrest.

Ask the patient to close his mouth and hold it during the first exposure.

Press and hold the exposure button. During the exposure a visible LED and a continuous audible signal indicate the presence of X-rays.

A sound of two long beeps will indicate the end of the emission.

If the operator interrupts the exposure the device will emit a sound of three short beeps.

If the exposure is interrupted by the equipment, it will emit a sound of five short beeps.

After the end of the x-ray exposure, the exposure button can be released. The equipment will then return to the starting position for the second exposure.

Ask the patient to open his mouth and hold it during the second exposure.

Press and hold the exposure button. During the exposure a visible LED and a continuous audible signal indicate the presence of X-rays.

A sound of two long beeps will indicate the end of the emission.

If the operator interrupts the exposure the device will emit a sound of three short beeps.

If the exposure is interrupted by the equipment, it will emit a sound of five short beeps.

After the end of the x-ray exposure, the exposure button can be released and the equipment will move to the patient's exit position. At this point, you can remove the patient from the device.

### Maxillary sinus program

After the patient has been prepared, ask them go to the main unit of the equipment.

The patient should be positioned in the standing unit. If necessary, sitting positioning is also possible.

Adjust the height of the equipment using the main control panel.

Ask the patient to lean the top of the nose on the TJM/MS chinrest.

Press and hold the exposure button. During the exposure a visible LED and a continuous audible signal indicate the presence of X-rays.

A sound of two long beeps will indicate the end of the emission.

If the operator interrupts the exposure the device will emit a sound of three short beeps.

If the exposure is interrupted by the equipment, it will emit a sound of five short beeps.

After the end of the x-ray exposure, the exposure button can be released and the equipment will move to the patient's exit position. At this point, you can remove the patient from the device.

## Panoramic programs

The panoramic programs are:



Standard Panoramic

### Region of interest

This exposure has constant vertical magnification in the dental arch region, excellent cut plane width and prioritizes homogeneity of exposure throughout the image.



Improved Orthogonality

This exhibition contains the standard panoramic program with improved orthogonality of the beams with respect to the angles, providing less reassembly of the teeth in the exhibition.



Fast Panoramic

This exposure has constant vertical magnification in the dental arch region, low cut plan width.



TMJ

This double exposure shows the region of the condyles with the mouth open and closed in the same image.

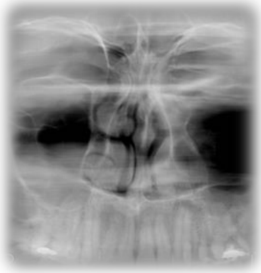

Maxillary sinus

This exposure focuses the maxillary sinus region.

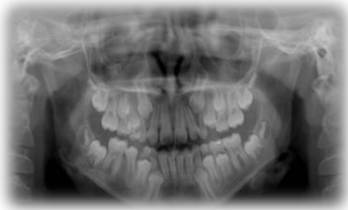

Infant

This exposure has a program 15% less than the standard panoramic program.



Bitewing

This exposure has a bitewing-like image program of the premolar and molar area, including the maxilla, mandible and branches.

## Sectional image processing

The equipment allows you to provide sectional images. To do this, before starting the exposure, simply select the section you want to perform (left, right or center).

On acquisition tab click on the menu above the image and select the section.

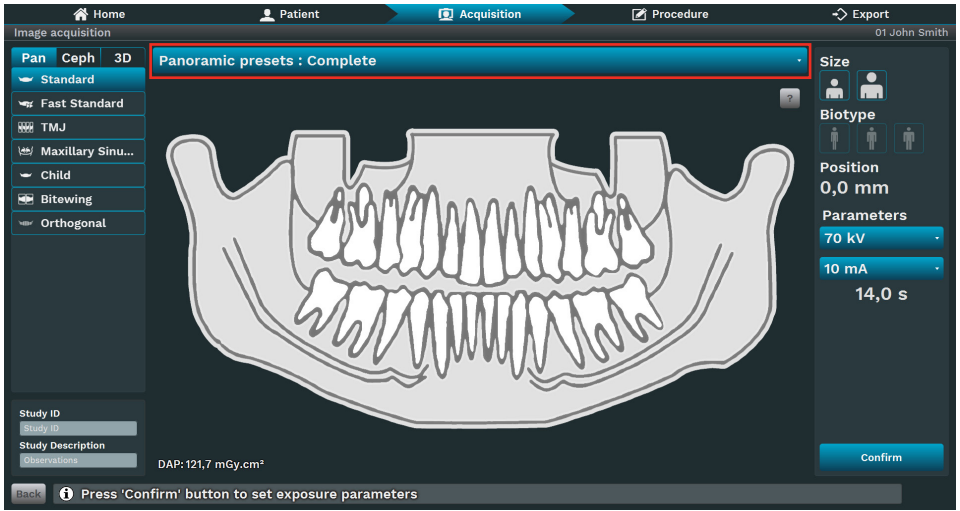

### Section Program



Right Section

### Region of interest

This exposure has constant vertical magnification in the right dental arch region, excellent cut plane width and prioritizes homogeneity of exposure throughout the image.



Left Section

This exposure has constant vertical magnification in the left dental arch region, excellent cut plane width and prioritizes homogeneity of exposure throughout the image.

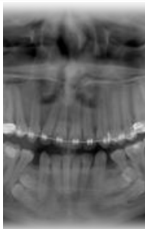

Center Section

This exposure has constant vertical magnification in the center dental arch region, excellent cut plane width and prioritizes homogeneity of exposure throughout the image.

## Mult Slice Function



Function only available for Panoramic Mult Slice configurations.

The Mult Slice function allows the reconstruction of the panoramic exam in various slice layer positions, so that the user can select the focus on specific anatomical structures depending on their needs. The Mult Slice function is enabled after image acquisition.

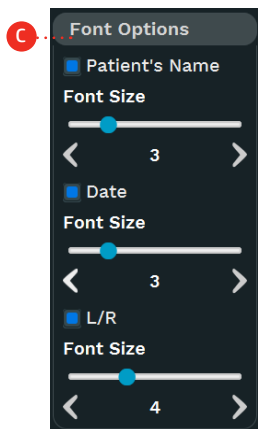
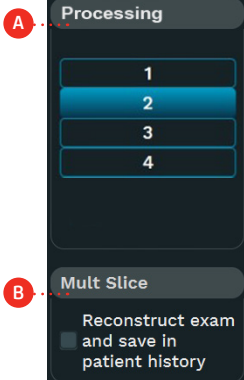
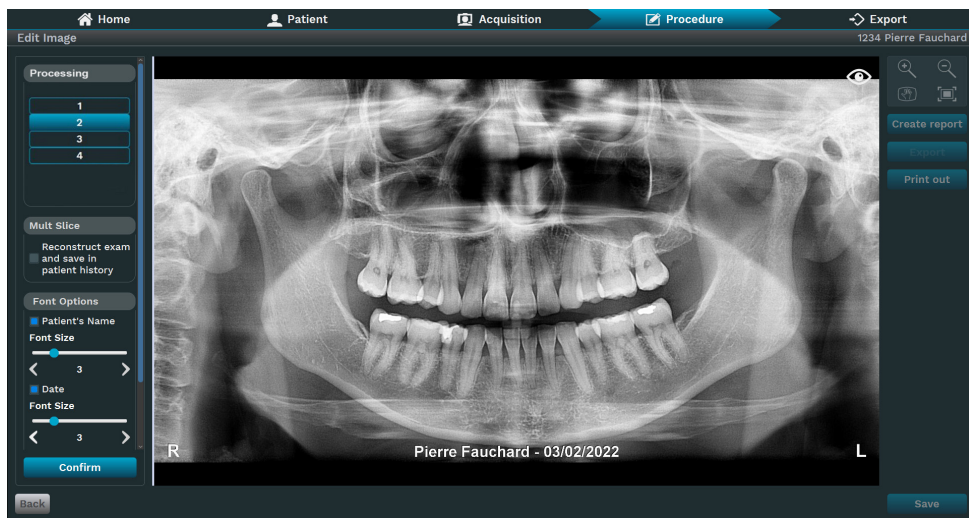

A. Image processing.

B. Multi Slice: Rebuild exam and save to patient history.

C. Font Options: it allows you to insert, remove or adjust the size of text in the image.

## 4.6.CEPHALOMETRIC EXAM

For this procedure it is necessary to use the positioners below



Nose support and ear rods



Carpal Support

Nose support and ears rods are used for head and neck cephalometric exams. For the carpal imaging procedure it is necessary to rotate the Nose support and use the carpal support. Refer to the images below for position reference on the cephalostat.



Nose support and ear rods

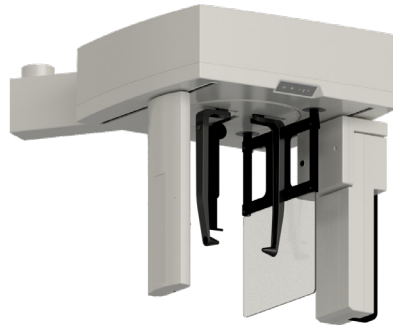

Carpal support

Before positioning the patient open the ear rods, to facilitate the patient's entry into the cephalostat.

### Patient positioning

To prevent cross-contamination, cover the nose support and the ears rods with disposable hygiene plastic covers.

#### A) Lateral cephalometric

Rotate the cephalostat to the lateral position and guide the patient to the equipment between the ear rods. Adjust the height of the equipment using the cephalostat control panel.

Align the ear rods with the patient's ears properly so their head does not move during operation and align the nose support with the patients nasion by adjusting its height.

Press the Laser key to turn on the positioning lasers in order to position the patient. The lasers automatically shut down after a period of time, or if the exposure button is pressed. If the lasers turn off before the patient is positioned, press the Laser button again to restart them.

Use the laser to position the Frankfort plan of the patient.

The laser must pass through the porion and patient's orbit. If necessary, adjust the inclination of the patient's head. Press the Ready button on the control panel to position the equipment in its capture position.

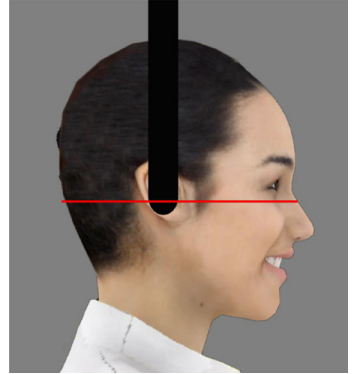

### B) Oblique cephalometric

Rotate the cephalostat to the 45° position and guide the patient to the equipment between the ear rods. Adjust the height of the equipment using the cephalostat control panel. Align the ear rods with the patient's ears properly so their head does not move during operation and align the nose support with the patient's nasion by adjusting its height.

Press the Laser key to turn on the positioning lasers in order to position the patient. The lasers automatically shut down after a period of time, or if the exposure button is pressed. If the lasers turn off before the patient is positioned, press the Laser button again to restart them.

Use the laser to position the Frankfort plan of the patient.

The laser must pass through the porion and patient's orbit. If necessary, adjust the inclination of the patient's head.

Press the Ready button on the control panel to position the equipment in its capture position.

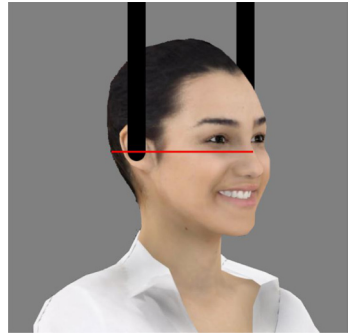

### C) Ricketts frontal

Rotate the cephalostat to the posteroanterior position with patient facing the sensor.

To prevent influence on the image, the nose support can be folded up.

Guide the patient to the equipment between the ear rods. Adjust the height of the equipment using the cephalostat control panel and align the ear rods with the patient's ears properly so their head does not move during operation.

Press the Laser key to turn on the positioning lasers in order to position the patient. The lasers automatically shut down after a period of time, or if the exposure button is pressed. If the lasers turn off before the patient is positioned, press the Laser button again to restart them.

Use the laser to position the Frankfort plan of the patient.



The laser must pass through the porion and patient's orbit. If necessary, adjust the inclination of the patient's head.  
Press the Ready button on the control panel to position the equipment in its capture position.

### D) Reverse towne

Turn the cephalostat to the anteroposterior position with patient facing the radiation source.  
Fold the nose support up. It is not used in this exam.  
Guide the patient to the equipment between the ear rods.  
Rotate the patient's head in the ventral direction about 30° below the horizontal plane. Adjust the height of the equipment using the cephalostat control panel and align the ear rods with the patient's ears correctly so that the head does not move during operation.  
Ask the patient to open his mouth as much as possible.

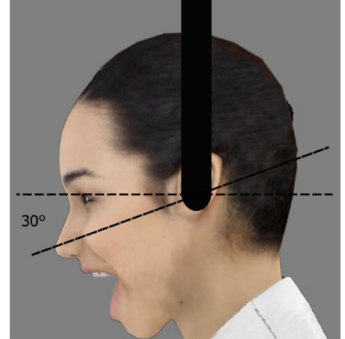

### E) PA Waters

Turn the cephalostat to the posteroanterior position with patient facing the sensor.  
Fold the nose support up. It is not used in this exam.  
Guide the patient to the equipment between the ear rods.  
Rotate the patient's head in the dorsal direction about 35-40° above the horizontal plane. Adjust the height of the equipment using the cephalostat control panel and align the ear rods with the patient's ears correctly so that the head does not move during operation.

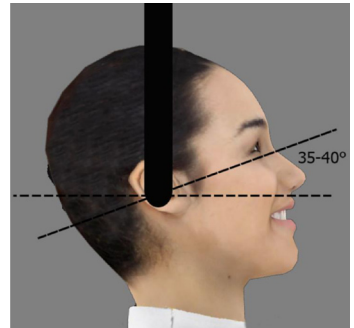

### F) Hirtz axial

Turn the cephalostat to the anteroposterior position with patient facing the radiation source.  
Fold the nose support up. It is not used in this exam.  
Guide the patient to the equipment between the ear rods.  
Rotate the patient's head in the dorsal direction until the apex (top) of the head is perpendicular to the active area of the sensor.  
If necessary, perform this examination with the patient sitting.  
Adjust the height of the equipment using the cephalostat control panel and align the ear rods with the patient's ears correctly so that the head does not move during operation.

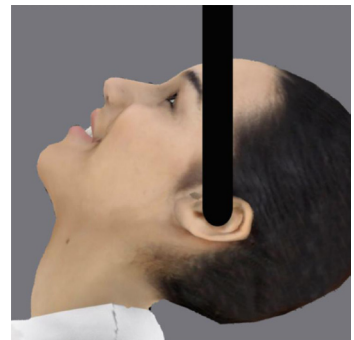



## G) Carpal

Turn the cephalostat to the posteroanterior position.

Fold the nose support up. It is not used in this exam.

Insert the carpal support in the equipment.

Adjust the height of the equipment using the cephalostat control panel and ask the patient to place a hand on the carpal support.

## Acquisition software - Cephalometric

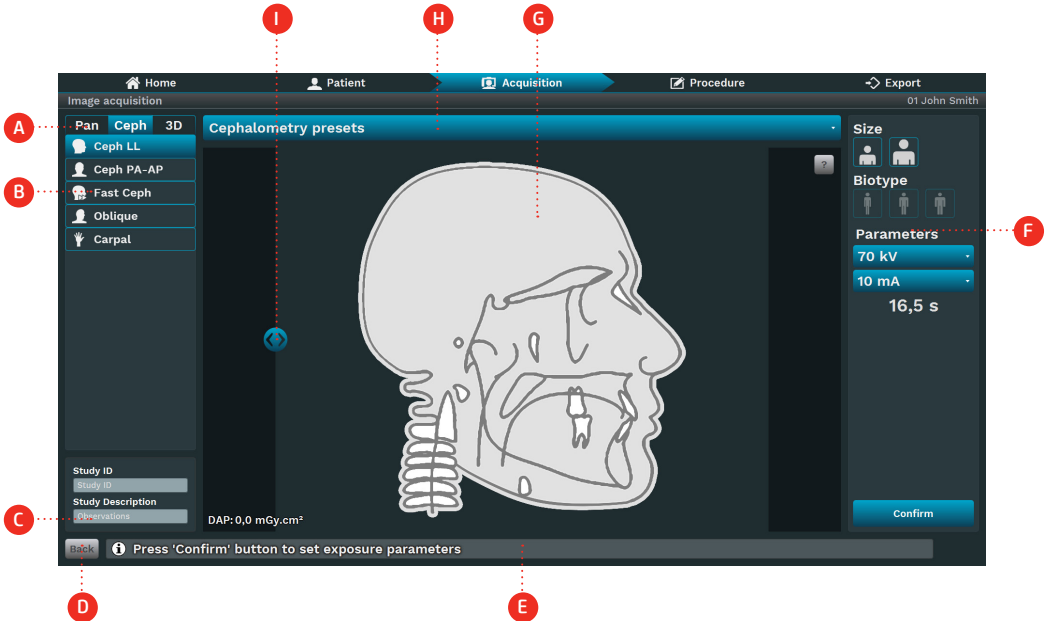

## Description

A. Exam type: Choose among Pan, Ceph, 3D or Scan exams options depending on the equipment model.

B. Program type: Choose among the programs according to the exam type. The programs are enabled according to equipment model.

C. Study ID/Study Description: Enter the study ID and study description of the exam.

D. Back: Return to previous window

E. Status Bar: Display the state of the equipment with operating messages.

F. Exposure parameters:

- Size: Child or Adult
- Biotype: Small, Medium or Large
- Kv Value • mA value
- Time: Exposure time in seconds

G. Profile Drawing: View a profile drawing according to the profile type.

H. Ceph presets: Select pre-defined exposure presets for ceph:

- Complete: Set the slider to capture full image.
- Low dose: Set the slider to capture partial image.

I. Ceph region: Use the slider to select the ceph region. The software updates the exposure time when the user moves the slider.



Ao selecionar tamanho e biótipo do paciente, o software indicará valores de KV e mA.

On tab of exam type selection (A), click CEPH.

Select the program to be performed (B). The selected program will be shown in the center area of the image.

Then select the exposure parameters (F).

If patient size and biotype are selected, the software will indicate KV and mA values, which are only starting points to be replaced by more specific user-developed protocols. The operator can manually adjust the value of KV and mA.

Note that the status bar (E) indicates Ready to Exposure.

The acquisition software will wait for the x-ray emission on the sensor to start the acquisition.

Inform the patient of all movements that the equipment will perform.

Ask the patient to breathe normally, and do not move during the examination.

Position yourself to a protected area without losing direct patient eye contact.

If the patient moves, stop the operation immediately by releasing the exposure button. If the exposure button is released during the radiographic examination, the emission and movement of the equipment will be interrupted immediately.

## Cephalometric programs

The cephalometric programs are:



Ceph

### Region of interest

With this programs, it is possible to obtain the following digital images:

- Lateral
- Oblique
- Ricketts Frontal
- PA Waters
- Reverse Towne
- Axial Hirtz
- Carpal



Fast Ceph

With this program is possible to perform a lateral ceph with a smaller area of exposure and thus a smaller dose for the patient.

### 4.7.TOMOGRAPHY EXAM

This exam will require the use of the chinrest for tomography.



Chin support for tomography

See the picture below for reference on how to position the parts in the chin mounting support.

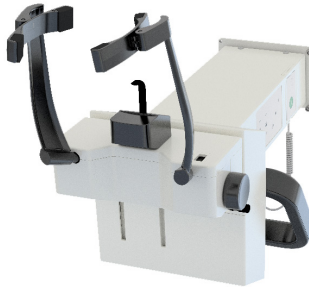

Before positioning the patient, fully open the temple support by rotating the side knob.

### Patient positioning

After the patient has been prepared, ask them go to the main unit of the equipment. The patient should be positioned upright. If necessary, the patient could be positioned seated. Adjust the height of the equipment using the main control panel.



The height adjustment movement starts slowly and then increases its speed. A patient positioned in the unit may be injured by moving parts. Monitor the patient and the movement of the unit during height adjustment.

If minor height corrections are required, press and release quickly the respective keys on the main panel.  
Open the mirror on the column to begin positioning the patient.  
Press the Laser key to turn on the positioning lasers in order to position the patient. The lasers automatically shut down after a period of time, or if the exposure button is pressed. If the lasers turn off before the patient is positioned, press the Laser button again to restart them.



The lasers used in the equipment are Class I lasers which indicates that the output power is minimal. However, as a good practice, intentionally avoid exposing the laser beam directly to the eyes of the operator and patient.

Use the lasers to position the FOV.  
The Mid-Sagittal Plane laser will indicate the center of the volume.

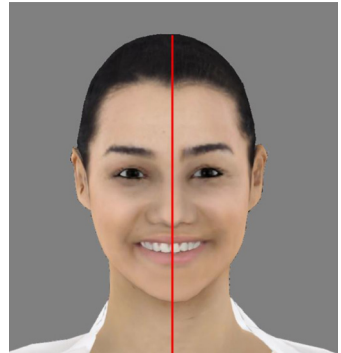

The lateral lasers will indicate the upper and lower limit of the FOV. Adjust the height of the chin rest support if necessary.

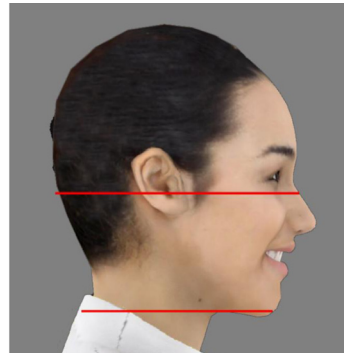

When finished positioning, close the column mirror.

## Acquisition software - Scout

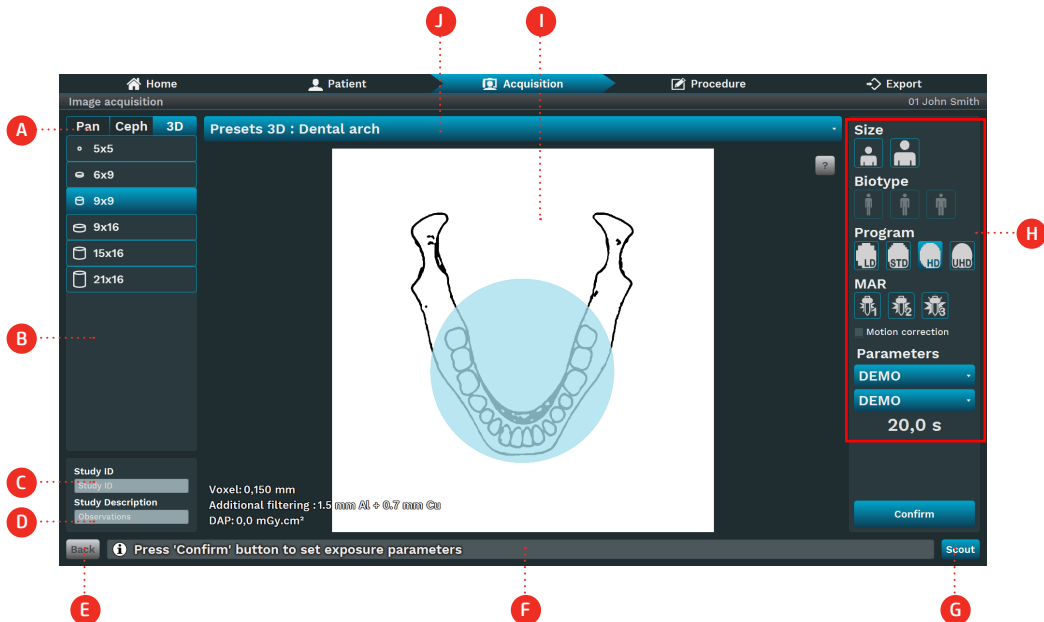

### Description

- A. Exam type: Choose among Pan, Ceph, 3D or Scan exams options depending on the equipment model.
- B. Field of View (FOV): Choose among FOV sizes available on the equipment.
- C. Study ID: Enter the study ID.
- D. Study Description: Enter the study description.
- E. Back: Return to previous window
- F. Status Bar: Display the state of the equipment with operating messages.
- G. Scout: Capture scout image.
- H. Exposure parameters:
  - Size: Child or Adult
  - Biotype: Small, Medium or Large
  - Program: Scout, LD, HD and UHD
  - Voltage: TubeHead kV value
  - Anodic current: TubeHead mA value
  - Time: Exposure time in seconds
  - MAR: Metal Artifact Reduction
- I. FOV region: View a representation of the FOV.
- J. Region list Bar: Select a region according to the FOV size.

On tab of exam type selection (A), click 3D.

Select the FOV size (B) and the FOV region (J).

The software will display the options of FOV region according to FOV size.

If the user selects the 5x5 FOV, the software will display an odontogram with the number of the tooth.

Otherwise, it will display three regions: dental arch, left condyle and right condyle

Select the type of programs (H), between LD, STD, HD or UHD.

If patient size and biotype are selected, the software will indicate kV and mA values, which are only starting points to be replaced by more specific user-developed protocols. The operator can manually adjust the value of kV and mA.

Click on Scout (G) to start the acquisition process.

The kV, mA and exposure time will be configured automatically.

The software will wait the X-Ray exposure to finish the acquisition and the status bar will display an acquisition message.

Inform the patient of all movements that the equipment will perform.

Ask the patient to breathe normally, and not move during the examination.

Position yourself to a protected area without losing direct patient eye contact.

Press and hold the exposure button. During this period a visible LED and a continuous audible signal will indicate the emission of X-rays.

A song of two long beeps will indicate the end of the emission.

If the patient moves, stop the operation immediately by releasing the exposure button. If the exposure button is released during the radiographic examination, the emission and movement of the equipment will be interrupted immediately.

After the exposure is complete, the exposure button can be released.

The software will display a frontal and lateral view of the FOV. Use the generated images to position the FOV.

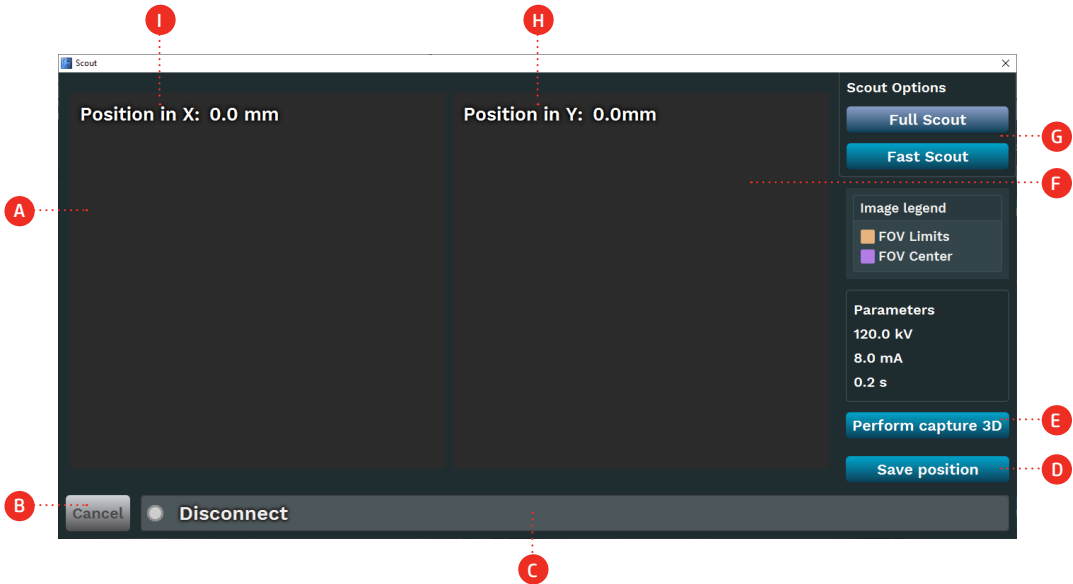

## Description

A. Lateral Scout: Image area to show the lateral scout. (Drag to the side to change the X position of the center of the FOV)

B. Cancel: Return to the previous window and cancel de exam.

- C. Status Bar: Display the state of the equipment with operating messages.
- D. Go to Position: Click to send the equipment to X and Y position.
- E. Capture 3D: Click to acquire a tomography with the previous selected program (LD, STD, HD and UHD).
- F. Frontal Scout: Image area to show the frontal scout. (Drag to the side to change the Y position of the center of the FOV)
- G. Scout Options: Select fast scout or full scout.
- H. Y position: Position (mm) of the FOV in Y-axis.
- I. X position: Position (mm) of the FOV in X-axis.

### Acquisition software - Tomography

Prepare the patient for the exposure. Please, follow the procedure described in the user manual of the equipment.

Choose the FOV and select the exposure parameters: size, biotype, voltage, anodic current and program. The software will wait the X-Ray exposure to finish the acquisition and start the reconstruction process. After that, the software will save the DICOM slices on the disk for visualization.

### Face scanning 3D



The facial scan sensor is an optional item. Check availability for your equipment

If your device has the optional facial scanning sensor, you can scan the patient's face and generate a 3D image of the same time. This function can be performed independently of the acquisition of the tomographic image or make both images at the same time.

## 0.2FS Function



Function available only for Tomography 0.2FS settings

The 0.2FS function allows the application of a filter to enhance details in the image, while preserving the resolution of the original image. The 0.2FS function is enabled after image acquisition.

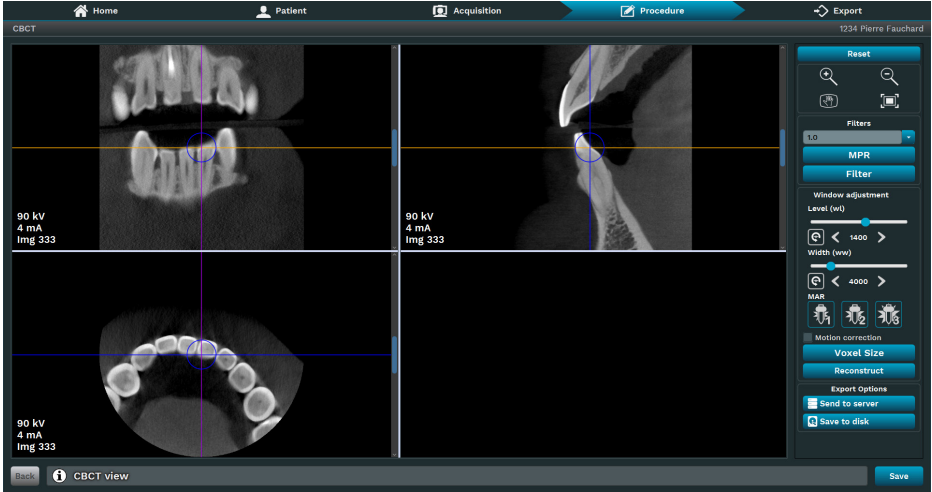

## Filters

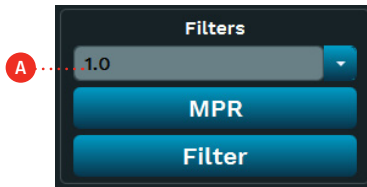

A. Thickness: it allows you to define the predefined thickness of the layer.



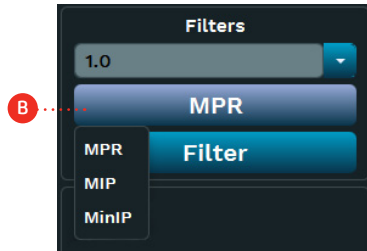

**B. MPR:** it allows you to reconstruct images in other planes to detail structures or even points of contrast to improve the diagnosis.

- **Multiplanar Reconstruction (MPR):** The MPR technique allows reconstructing images for other viewing planes from a single series. In this way, it is possible to analyze the exam in different sections, which contributes to the visualization of the structures in a three-dimensional way. The images are generated without loss of quality, which guarantees the validity of the new series generated from the exam.

- **Maximum or Minimum Intensity Projection (Mip/Minip):** When using the Mip/Minip technique, it is possible to apply intensity attenuation in some structure to manipulate tomography images. With this, structures or even contrast points can be highlighted to improve the diagnosis.

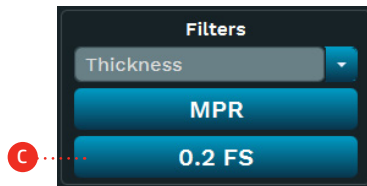

**C. Filter:** select the 0.2FS function to enhance details in the image.

## Tomographic programs

The tomography programs are:



Tomography

### Region of interest

With this program it is possible to select the area of interest and perform a 3D image and tomographic cuts



Quick Scout

With this program, it is possible to obtain a quick lateral image to position the patient before the tomographic image.



Full Scout

With this program, it is possible to obtain a lateral and frontal image to position the patient before the tomographic image.



### 4.8.SCAN

This function makes it possible to scan dental impressions in order to generate a digital 3D model. For this procedure it is necessary to use the prosthesis support.

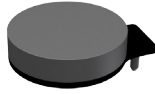

Prosthesis Support

See the image below for reference on how to position the denture support on the chinrest table.



At the time of prosthesis acquisition, the operator must ensure that the patient is free from any unnecessary exposure to ionizing radiation.

## Acquisition software - Scan

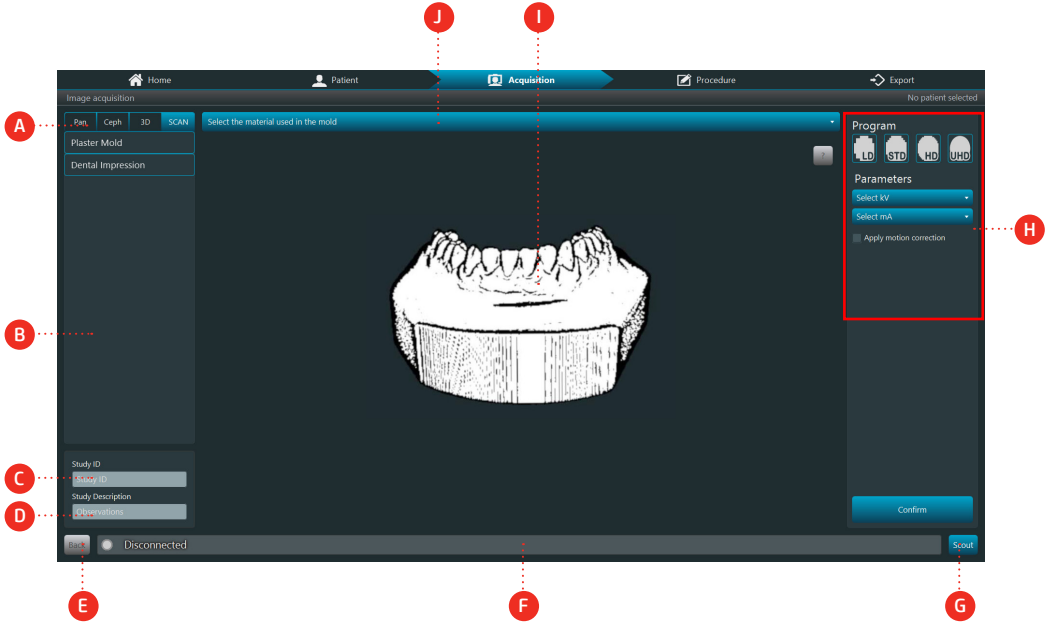

### Description

- A. Exam type: choose between Pan, Tele, 3D, or Scan exam options, depending on the device model.
- B. Field of view: choose the scanning options available on the device.
- C. Study ID: Enter the study ID.
- D. Study Description: Enter the study description.
- E. Back: Back to the previous window
- F. Status bar: Displays the equipment status with operating messages.
- G. Scout: Capture the scout image.
- H. Exposure parameters:
  - Program: Scout, LD, STD, HD and UHD
  - Voltage: TubeHead kV value
  - Anodic current: TubeHead mA value
- I. Profile drawing: View a profile drawing according to the profile type.
- J. Mold Presets: Select predefined mold presets to scan.

### 4.9.RECOMMENDATIONS FOR PEDIATRIC EXAMINATIONS

- Radiographs should be taken only when there is an expectation that the diagnostic yield will affect patient care. The dentist must weigh the benefits of obtaining radiographs against the patient's risk of radiation exposure.
- Because the effects of radiation exposure accumulate over time, every effort must be made to minimize the patient's exposure.
- Use protective lead apron and thyroid collars,
- Use pediatric program or low dosage and select the lowest permissible exposure time.
- There may be clinical circumstances for which a radiograph is indicated, but a diagnostic image cannot be obtained. For example, the patient may be unable to cooperate for the dentist.

PATIENT AGE AND DENTAL DEVELOPMENTAL STAGE <sup>1</sup>					
TYPE OF ENCOUNTER	Child with Primary Dentition (prior to eruption of first permanent tooth)	Child with Transitional Dentition (after eruption of first permanent tooth)	Adolescent with Permanent Dentition (prior to eruption of third molars)	Adult, Dentate or Partially Edentulous	Adult, Edentulous
New Patient* being evaluated for oral diseases	Individualized radiographic exam consisting of selected periapical/occlusal views and/or posterior bitewings if proximal surfaces cannot be visualized or probed. Patients without evidence of disease and with open proximal contacts may not require a radiographic	Individualized radiographic exam consisting of posterior bitewings with panoramic exam or posterior bitewings and selected periapical images.	Individualized radiographic exam consisting of posterior bitewings with panoramic exam or posterior bitewings and selected periapical images. A full mouth intraoral radiographic exam is preferred when the patient has clinical evidence of generalized oral disease or a history of extensive dental treatment.		Individualized radiographic exam, based on clinical signs and symptoms.
Recall Patient* with clinical caries or at increased risk for caries**	Posterior bitewing exam at 6-12 month intervals if proximal surfaces cannot be examined visually or with a probe			Posterior bitewing exam at 6-18 month intervals	Not applicable

<p>Recall Patient* with no clinical caries and not at increased risk for caries**</p>	<p>Posterior bitewing exam at 12-24 month intervals if proximal surfaces cannot be examined visually or with a probe</p>	<p>Posterior bitewing exam at 18-36 month intervals</p>	<p>Posterior bitewing exam at 24-36 month intervals</p>	<p>Not applicable</p>
<p>Recall Patient* with periodontal disease</p>	<p>Clinical judgment as to the need for and type of radiographic images for the evaluation of periodontal disease. Imaging may consist of, but is not limited to, selected bitewing and/or periapical images of areas where periodontal disease (other than nonspecific gingivitis) can be demonstrated clinically.</p>			<p>Not applicable</p>
<p>Patient (New and Recall) for monitoring of dentofacial growth and development, and/or assessment of dental/skeletal relationships</p>	<p>Clinical judgment as to need for and type of radiographic images for evaluation and/or monitoring of dentofacial growth and development or assessment of dental and skeletal relationships</p>	<p>Clinical judgment as to need for and type of radiographic images for evaluation and/or monitoring of dentofacial growth and development, or assessment of dental and skeletal relationships. Panoramic or periapical exam to assess developing third molars</p>	<p>Usually not indicated for monitoring of growth and development. Clinical judgment as to the need for and type of radiographic image for evaluation of dental and skeletal relationships.</p>	
<p>Patient with other circumstances including, but not limited to, proposed or existing implants, other dental and craniofacial pathoses, restorative/endodontic needs, treated periodontal disease and caries remineralization</p>	<p>Clinical judgment as to need for and type of radiographic images for evaluation and/or monitoring of these conditions</p>			



These recommendations are subject to clinical judgment and may not apply to every patient. It is the dentist's responsibility to minimize the patient's exposure.

\* Clinical situations for which radiographs may be indicated include, but are not limited to:

### **A. Positive Historical Findings**

01. Previous periodontal or endodontic treatment
02. History of pain or trauma
03. Familial history of dental anomalies
04. Postoperative evaluation of healing
05. Remineralization monitoring
06. Presence of implants, previous implant-related pathosis or evaluation for implant placement

### **B. Positive Clinical Signs/Symptoms**

01. Clinical evidence of periodontal disease
02. Large or deep restorations
03. Deep carious lesions
04. Malposed or clinically impacted teeth
05. Swelling
06. Evidence of dental/facial trauma
07. Mobility of teeth
08. Sinus tract ("fistula")
09. Clinically suspected sinus pathosis
10. Growth abnormalities
11. Oral involvement in known or suspected systemic disease
12. Positive neurologic findings in the head and neck
13. Evidence of foreign objects
14. Pain and/or dysfunction of the temporomandibular joint
15. Facial asymmetry
16. Abutment teeth for fixed or removable partial prosthesis
17. Unexplained bleeding
18. Unexplained sensitivity of teeth
19. Unusual eruption, spacing or migration of teeth
20. Unusual tooth morphology, calcification or color
21. Unexplained absence of teeth
22. Clinical tooth erosion
23. Peri-implantitis

\*\*Factors increasing risk for caries may be assessed using the ADA Caries Risk Assessment forms (0 – 6 years of age and over 6 years of age).

<sup>1</sup>U.S. Department of Health and Human Services. Dental Radiographic Examinations: Recommendations for Patient Selection and Limiting Radiation Exposure. Available at [http://www.ada.org/~media/ADA/Member%20Center/Files/Dental\\_Radiographic\\_Examinations\\_2012.ashx](http://www.ada.org/~media/ADA/Member%20Center/Files/Dental_Radiographic_Examinations_2012.ashx). Accessed November 2, 2015.

<sup>2</sup>The American Academy of Pediatric Dentistry. Guideline on Prescribing Dental Radiographs for Infants, Children, Adolescents, and Persons with Special Health Care Needs. Available at [http://www.aapd.org/media/policies\\_guidelines/e\\_radiographs.pdf](http://www.aapd.org/media/policies_guidelines/e_radiographs.pdf). Accessed November 2, 2015.

<sup>3</sup>U.S. Department of Health and Human Services. Pediatric X-ray Imaging. Available at <http://www.fda.gov/Radiation-EmittingProducts/RadiationEmittingProductsandProcedures/MedicalImaging/ucm298899.htm>. Accessed November 2, 2015.

# 5

## DOSE INFORMATION



## 5.DOSE INFORMATION

### 5.1.DOSE CALCULATION

The table below indicate the parameters for calculate the "Dose-Area Product" (DAP) for all exposure procedures. The "Dose-Area Product" (DAP) measure is a measure of the dose in Gray multiplied by the irradiated area.

For the calculation of Air Kerma use the following calculation.

$$K_{air} = \frac{DAP}{A}$$

Where  $K_{air}$  is the Air Kerma and  $A$  is the irradiated area.

The radiation dose was measured using a specific ionization chamber for such a method that meets the standard IEC 60580:2000 for the radiation quality of the product, mounted juxtaposed to the tubehead, without the need to use of representative test object of an average patient

Please use theses information only as a reference. If necessary, change the values according to your needs.



DAP and Air Kerma values may vary due to measurement errors, as well as system and instrument variations. To compensate for such errors, a tolerance of 50% must be taken into account.

#### 5.1.1.DAP for panoramic and cephalometric exam

For load values selected by the operator, the dose indications have to be calculated. For the dose indication use the following calculation.

$$DAP_{2D} = k * mA * Time$$

Where  $k$  is a dose / area factor that depends on the KV and selected examination

The factor  $k$  should be selected from the table below

Voltage kV	Factor $k$ (mGy.cm <sup>2</sup> /mAs)	
	Panoramic	Ceph
60.0	0.721	0.106
62.5	0.801	0.118
65.0	0.882	0.130
67.5	0.962	0.142
70.0	1.043	0.153
72.5	1.123	0.165
75.0	1.204	0.177
77.5	1.284	0.189
80.0	1.365	0.200
82.5	1.445	0.212
85.0	1.526	0.224
87.5	1.606	0.236
90.0	1.687	0.247

### 5.1.2.DAP for tomography exam

For load values selected by the operator, the dose indications have to be calculated. For the dose indication use the following calculation.

$$DAP_{3D} = k * mA$$

Where  $k$  is a dose / area factor that depends on the KV and selected examination. The factor  $k$  should be selected from the table below

		k Factor (mGy.cm <sup>2</sup> /mA)				
		FOV H (cm) X D (cm) - Sensor 1511				
Mode	Voltage (kV)	5x5	6x9	9x9	9x11	9x14
Fast Scout	90	0.1	0.2	0.3	0.3	0.3
	120	0.3	0.7	0.8	0.8	0.8
Full Scout	90	0.3	0.5	0.6	0.6	0.6
	120	0.7	1.3	1.7	1.7	1.7
LD	90	12.6	24.0	31.2	31.2	31.2
	120	33.8	64.4	83.9	83.9	83.9
STD	90	18.9	35.8	46.8	46.8	46.8
	120	50.8	97.0	126.2	126.2	126.2
HD	90	25.1	47.9	62.4	62.4	62.4
	120	68.3	128.8	168.5	168.5	168.5
UDH	90	31.7	59.8	78.0	78.0	78.0
	120	85.2	161.4	210.2	210.2	210.2

		k Factor (mGy.cm <sup>2</sup> /mA)					
		FOV H (cm) X D (cm) - Sensor 1515					
Mode	Voltage (kV)	5x5	6x9	9x9	9x16	15x16	21x16
Fast Scout	90	0.02	0.07	0.12	0.12	0.21	0.32
	120	0.20	0.39	0.72	0.72	1.50	2.21
Full Scout	90	0.07	0.12	0.21	0.21	0.44	0.67
	120	0.39	0.85	1.50	1.50	2.93	4.23
LD	90	3.24	6.19	10.81	10.81	21.55	32.36
	120	21.91	41.73	72.87	72.87	145.73	218.60
STD	90	4.85	9.25	16.15	16.15	32.36	48.51
	120	32.83	62.79	109.53	109.53	218.60	328.12
HD	90	6.49	12.37	21.55	21.55	43.17	64.72
	120	44.20	83.40	145.73	145.73	291.92	437.65
UDH	90	8.17	15.43	26.96	26.96	53.91	80.87
	120	55.19	104.46	182.39	182.39	364.78	547.171

		k Factor (mGy.cm <sup>2</sup> /mA )					
		FOV H (cm) X D (cm) – Sensor 2022					
Mode	Voltage (kV)	5x5	6x9	9x9	9x16	14x16	23x16
Fast Scout	90	0.02	0.09	0.12	0.14	0.21	0.39
	120	0.20	0.52	0.72	0.98	1.43	2.67
Full Scout	90	0.07	0.16	0.21	0.30	0.41	0.78
	120	0.39	1.11	1.50	1.95	2.86	5.46
LD	90	3.24	8.10	10.81	14.40	21.07	39.33
	120	21.91	54.73	72.87	97.31	142.81	265.79
STD	90	4.85	12.19	16.15	21.55	31.63	58.95
	120	32.83	82.55	109.53	145.73	213.98	398.91
HD	90	6.49	16.26	21.55	28.75	42.21	78.57
	120	44.20	109.92	145.73	194.61	285.16	531.57
UDH	90	8.17	20.29	26.96	35.95	52.72	98.28
	120	55.19	137.28	182.39	243.04	356.79	664.63

## 5.2.SCATTER RADIATION

Method: Measurement of scattered radiation at the skull level (anthropomorphic phantom) in each of the positions during the specific exposure time for each exam modality.

### Scattered Radiation – Panoramic Exposure

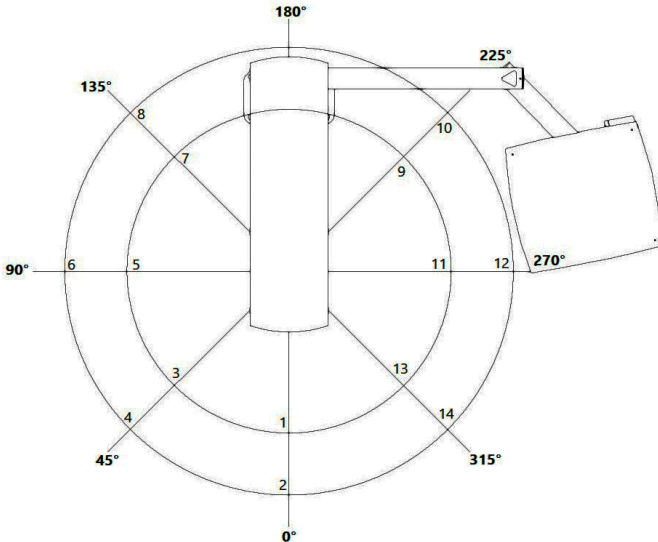

### Acquisition Parameters:

Tube anodic current: 12.5 mA

Tube voltage: 90 kV

Exposure time: 14 s

Measuring device: Ionization Chamber RADCAL Model 10x6-180 – N/S 08-0127 (calibration certificate N°: LABPROSAUD-C023-20).

Angle [°]	Measured Point	Distance [m]	Measured Dose [μGy]	Dose/mAs [μGy/mAs]
0	1	0.6	1.68	0.010
	2	0.9	1.03	0.006
45	3	0.6	1.98	0.011
	4	0.9	1.07	0.006
90	5	0.6	1.72	0.010
	6	0.9	1.16	0.007
135	7	0.6	1.70	0.010
	8	0.9	1.00	0.006
225	9	0.6	1.96	0.011
	10	0.9	1.32	0.008
270	11	0.6	1.78	0.010
	12	0.9	1.13	0.006
315	13	0.6	2.23	0.013
	14	0.9	1.17	0.007

## Scattered Radiation – Cephalometric Exposure

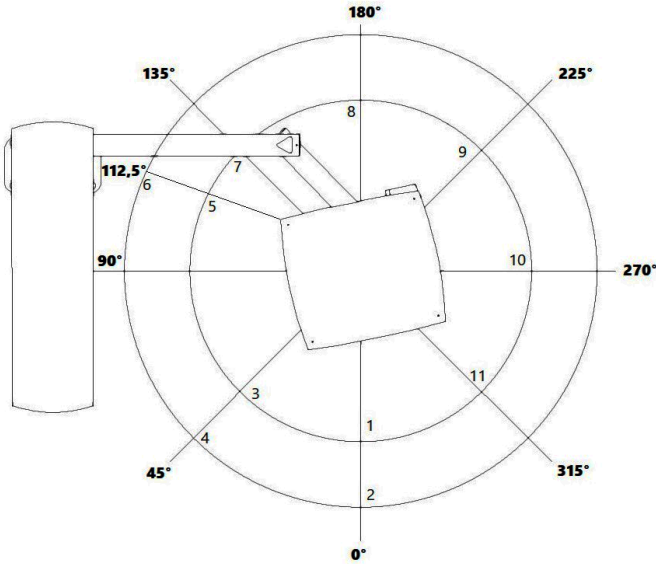

### Acquisition Parameters:

Tube anodic current: 12.5 mA

Tube voltage: 90 kV

Exposure time: 16.5 s

Measuring device: Ionization Chamber RADCAL Model 10x6-180 – N/S 08-0127 (calibration certificate N°: LABPROSAUD-C023-20).

Angle [°]	Measured Point	Distance [m]	Measured Dose [μGy]	Dose/mAs [μGy/mAs]
0	1	0.6	2.82	0.014
	2	0.9	1.44	0.007
45	3	0.6	6.09	0.030
	4	0.9	2.89	0.014
112.5	5	0.6	20.50	0.099
	6	0.9	7.47	0.036
135	7	0.6	4.13	0.020
180	8	0.6	2.96	0.014
225	9	0.6	12.74	0.062
270	10	0.6	1.21	0.006
315	11	0.6	1.77	0.009

**Note:** At 90°, we have direct beam contribution, so measurements 5 and 6 were performed at an angle of 112.5°.

Scattered Radiation – CBCT Exposure

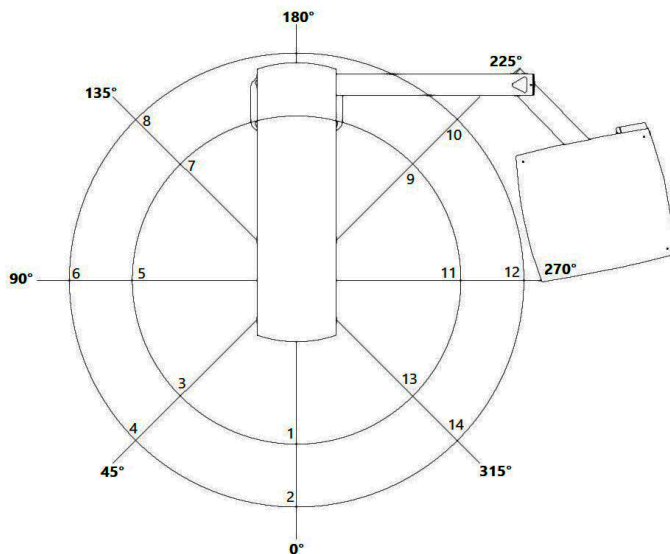

**Acquisition Parameters:**

Tube anodic current: 12.5 mA

Tube voltage: 90 kV

Exposure time: 15 s

Measuring device: Ionization Chamber RADCAL Model 10x6-180 – N/S 08-0127 (calibration certificate N°: LABPROSAUD-C023-20).

Angle [°]	Measured Point	Distance [m]	Measured Dose [µGy]	Dose/mAs [µGy/mAs]
0	1	0.6	19.96	0.106
	2	0.9	9.83	0.052
45	3	0.6	10.10	0.054
	4	0.9	10.34	0.055
90	5	0.6	22.95	0.122
	6	0.9	11.10	0.059
135	7	0.6	23.15	0.123
	8	0.9	11.66	0.062
225	9	0.6	26.37	0.141
	10	0.9	12.96	0.069
270	11	0.6	29.59	0.158
	12	0.9	14.06	0.075
315	13	0.6	27.23	0.145
	14	0.9	12.07	0.064

### Acquisition Parameters:

Tube anodic current: 8.0 mA

Tube voltage: 120 kV

Exposure time: 20 s

Measuring device: Ionization Chamber RADCAL Model 10x6-180 – N/S 08-0127 (calibration certificate N°: LABPROSAUD-C023-20).

Angle [°]	Measured Point	Distance [m]	Measured Dose [μGy]	Dose/mAs [μGy/mAs]
0	1	0.6	41.97	0.262
	2	0.9	19.86	0.124
45	3	0.6	46.90	0.293
	4	0.9	21.29	0.133
90	5	0.6	38.10	0.238
	6	0.9	23.08	0.144
135	7	0.6	53.47	0.334
	8	0.9	23.81	0.149
225	9	0.6	39.96	0.250
	10	0.9	26.16	0.164
270	11	0.6	61.75	0.386
	12	0.9	26.62	0.166
315	13	0.6	55.97	0.350
	14	0.9	24.65	0.154

### 5.3. RECOMMENDED X-RAY EXPOSURE TABLE

#### PAN

Standard Panoramic Mode

Type of patient	Biotype	Recommended X-ray exposure			DAP (mGy*cm <sup>2</sup> )
		kV	mA	Exposure time (s)	
Child	Small	60	6.3	14.0	56.0
	Medium	62.5	7.1	14.0	68.9
	Large	65	8	14.0	84.1
Adult	Small	70	8	14.0	97.3
	Medium	72.5	9	14.0	116.9
	Large	75	10	14.0	138.7

Fast Standard Panoramic Mode

Type of patient	Biotype	Recommended X-ray exposure			DAP (mGy*cm <sup>2</sup> )
		kV	mA	Exposure time (s)	
Child	Small	60	6.3	10.0	40.0
	Medium	62.5	7.1	10.0	49.2
	Large	65	8	10.0	60.1
Adult	Small	70	8	10.0	69.5
	Medium	72.5	9	10.0	83.5
	Large	75	10	10.0	99.1

TMJ mode

Type of patient	Biotype	Recommended X-ray exposure			DAP (mGy*cm <sup>2</sup> )
		kV	mA	Exposure time (s)	
Child	Small	60	6.3	10.0	40.0
	Medium	62.5	7.1	10.0	49.2
	Large	65	8	10.0	60.1
Adult	Small	70	8	10.0	69.5
	Medium	72.5	9	10.0	83.5
	Large	75	10	10.0	99.1



### Maxillary Sinus Mode

Type of patient	Biotype	Recommended X-ray exposure			DAP (mGy*cm <sup>2</sup> )
		kV	mA	Exposure time (s)	
Child	Small	60	6.3	8.0	32.0
	Medium	62.5	7.1	8.0	39.4
	Large	65	8	8.0	48.1
Adult	Small	70	8	8.0	55.6
	Medium	72.5	9	8.0	66.8
	Large	75	10	8.0	79.3

### Child Mode

Type of patient	Biotype	Recommended X-ray exposure			DAP (mGy*cm <sup>2</sup> )
		kV	mA	Exposure time (s)	
Child	Small	60	6.3	10.0	40.0
	Medium	62.5	7.1	10.0	49.2
	Large	65	8	10.0	60.1
Adult	Small	70	8	10.0	69.5
	Medium	72.5	9	10.0	83.5
	Large	75	10	10.0	99.1

### Bitewing Mode

Type of patient	Biotype	Recommended X-ray exposure			DAP (mGy*cm <sup>2</sup> )
		kV	mA	Exposure time (s)	
Child	Small	60	6.3	7.6	30.4
	Medium	62.5	7.1	7.6	37.4
	Large	65	8	7.6	45.7
Adult	Small	70	8	7.6	52.8
	Medium	72.5	9	7.6	63.5
	Large	75	10	7.6	75.3

### Orthogonal Mode

Type of patient	Biotype	Recommended X-ray exposure			DAP (mGy*cm <sup>2</sup> )
		kV	mA	Exposure time (s)	
Child	Small	60	6.3	14.0	56.0
	Medium	62.5	7.1	14.0	68.9
	Large	65	8	14.0	84.1
Adult	Small	70	8	14.0	97.3
	Medium	72.5	9	14.0	116.9
	Large	75	10	14.0	138.7

### CEPH

#### Lateral Ceph Mode

Type of patient	Biotype	Recommended X-ray exposure			DAP (mGy*cm <sup>2</sup> )
		kV	mA	Exposure time (s)	
Child	Small	80	10	16.5	33.7
	Medium	82.5	10	16.5	35.6
	Large	85	10	16.5	37.6
Adult	Small	85	12.5	16.5	47.0
	Medium	87.5	12.5	16.5	49.5
	Large	90	12.5	16.5	51.8

#### PA-AP Ceph Mode

Type of patient	Biotype	Recommended X-ray exposure			DAP (mGy*cm <sup>2</sup> )
		kV	mA	Exposure time (s)	
Child	Small	80	10	16.5	33.7
	Medium	82.5	10	16.5	35.6
	Large	85	10	16.5	37.6
Adult	Small	85	12.5	16.5	47.0
	Medium	87.5	12.5	16.5	49.5
	Large	90	12.5	16.5	51.8

### Fast Ceph Mode

Type of patient	Biotype	Recommended X-ray exposure			DAP (mGy*cm <sup>2</sup> )
		kV	mA	Exposure time (s)	
Child	Small	80	10	10.0	20.4
	Medium	82.5	10	10.0	21.6
	Large	85	10	10.0	22.8
Adult	Small	85	12.5	10.0	28.5
	Medium	87.5	12.5	10.0	30.0
	Large	90	12.5	10.0	31.4

### Oblique Mode

Type of patient	Biotype	Recommended X-ray exposure			DAP (mGy*cm <sup>2</sup> )
		kV	mA	Exposure time (s)	
Child	Small	80	10	16.5	33.7
	Medium	82.5	10	16.5	35.6
	Large	85	10	16.5	37.6
Adult	Small	85	12.5	16.5	47.0
	Medium	87.5	12.5	16.5	49.5
	Large	90	12.5	16.5	51.8

### Carpal Mode

Type of patient	Biotype	Recommended X-ray exposure			DAP (mGy*cm <sup>2</sup> )
		kV	mA	Exposure time (s)	
Child	Small	80	10	16.5	33.7
	Medium	82.5	10	16.5	35.6
	Large	85	10	16.5	37.6
Adult	Small	85	12.5	16.5	47.0
	Medium	87.5	12.5	16.5	49.5
	Large	90	12.5	16.5	51.8

### 3D

#### 5x5

LD 90kV Program

Type of patient	Biotype	Recommended X-ray exposure			DAP (mGy*cm <sup>2</sup> )
		kV	mA	Exposure time (s)	
Child	Small	90.0	2.0	10.0	108.0
	Medium	90.0	2.5	10.0	135.0
	Large	90.0	3.2	10.0	172.8
Adult	Small	90.0	2.5	10.0	135.0
	Medium	90.0	3.2	10.0	172.8
	Large	90.0	4.0	10.0	216.0

LD 120 Program

Type of patient	Biotype	Recommended X-ray exposure			DAP (mGy*cm <sup>2</sup> )
		kV	mA	Exposure time (s)	
Child	Small	120.0	4.5	10.0	234.0
	Medium	120.0	5.6	10.0	291.2
	Large	120.0	6.3	10.0	327.6
Adult	Small	120.0	6.3	10.0	327.6
	Medium	120.0	7.1	10.0	369.2
	Large	120.0	8.0	10.0	416.0

STD 90kV Program

Type of patient	Biotype	Recommended X-ray exposure			DAP (mGy*cm <sup>2</sup> )
		kV	mA	Exposure time (s)	
Child	Small	90.0	2.0	20.0	216.0
	Medium	90.0	2.5	20.0	270.0
	Large	90.0	3.2	20.0	345.6
Adult	Small	90.0	2.5	20.0	270.0
	Medium	90.0	3.2	20.0	345.6
	Large	90.0	4.0	20.0	432.0

STD 120kV Program

Type of patient	Biotype	Recommended X-ray exposure			DAP (mGy*cm <sup>2</sup> )
		kV	mA	Exposure time (s)	
Child	Small	120.0	5.0	15.0	390.0
	Medium	120.0	5.6	15.0	436.8
	Large	120.0	6.3	15.0	491.4
Adult	Small	120.0	6.3	15.0	491.4
	Medium	120.0	7.1	15.0	553.8
	Large	120.0	8.0	15.0	624.0

HD 90kV Program

Type of patient	Biotype	Recommended X-ray exposure			DAP (mGy*cm <sup>2</sup> )
		kV	mA	Exposure time (s)	
Child	Small	90.0	2.0	25.0	270.0
	Medium	90.0	2.5	25.0	337.5
	Large	90.0	3.2	25.0	432.0
Adult	Small	90.0	2.5	25.0	337.5
	Medium	90.0	3.2	25.0	432.0
	Large	90.0	4.0	25.0	540.0

HD 120kV Program

Type of patient	Biotype	Recommended X-ray exposure			DAP (mGy*cm <sup>2</sup> )
		kV	mA	Exposure time (s)	
Child	Small	120.0	5.0	20.0	520.0
	Medium	120.0	5.6	20.0	582.4
	Large	120.0	6.3	20.0	655.2
Adult	Small	120.0	6.3	20.0	655.2
	Medium	120.0	7.1	20.0	738.4
	Large	120.0	8.0	20.0	832.0

UHD 90kV Program

Type of patient	Biotype	Recommended X-ray exposure			DAP (mGy*cm <sup>2</sup> )
		kV	mA	Exposure time (s)	
Child	Small	90.0	2.0	25.0	270.0
	Medium	90.0	2.5	25.0	337.5
	Large	90.0	3.2	25.0	432.0
Adult	Small	90.0	2.5	25.0	337.5
	Medium	90.0	3.2	25.0	432.0
	Large	90.0	4.0	25.0	540.0

UHD 120kV Program

Type of patient	Biotype	Recommended X-ray exposure			DAP (mGy*cm <sup>2</sup> )
		kV	mA	Exposure time (s)	
Child	Small	120.0	5.0	25.0	650.0
	Medium	120.0	5.6	25.0	728.0
	Large	120.0	6.3	25.0	819.0
Adult	Small	120.0	6.3	25.0	819.0
	Medium	120.0	6.3	25.0	819.0
	Large	120.0	6.3	25.0	819.0

6x9

LD 90kV Program

Type of patient	Biotype	Recommended X-ray exposure			DAP (mGy*cm <sup>2</sup> )
		kV	mA	Exposure time (s)	
Child	Small	90.0	2.0	10.0	206.0
	Medium	90.0	2.5	10.0	257.5
	Large	90.0	3.2	10.0	329.6
Adult	Small	90.0	2.5	10.0	257.5
	Medium	90.0	3.2	10.0	329.6
	Large	90.0	4.0	10.0	412.0

LD 120kV Program

Type of patient	Biotype	Recommended X-ray exposure			DAP (mGy*cm <sup>2</sup> )
		kV	mA	Exposure time (s)	
Child	Small	120.0	5.0	10.0	495.0
	Medium	120.0	5.6	10.0	554.4
	Large	120.0	6.3	10.0	623.7
Adult	Small	120.0	6.3	10.0	623.7
	Medium	120.0	7.1	10.0	702.9
	Large	120.0	8.0	10.0	792.0

STD 90kV Program

Type of patient	Biotype	Recommended X-ray exposure			DAP (mGy*cm <sup>2</sup> )
		kV	mA	Exposure time (s)	
Child	Small	90.0	2.0	20.0	412.0
	Medium	90.0	2.5	20.0	515.0
	Large	90.0	3.2	20.0	659.2
Adult	Small	90.0	2.5	20.0	515.0
	Medium	90.0	3.2	20.0	659.2
	Large	90.0	4.0	20.0	824.0

STD 120kV Program

Type of patient	Biotype	Recommended X-ray exposure			DAP (mGy*cm <sup>2</sup> )
		kV	mA	Exposure time (s)	
Child	Small	120.0	5.0	15.0	742.5
	Medium	120.0	5.6	15.0	831.6
	Large	120.0	6.3	15.0	935.5
Adult	Small	120.0	6.3	15.0	935.5
	Medium	120.0	7.1	15.0	1054.3
	Large	120.0	8.0	15.0	1188.0

### HD 90kV Program

Type of patient	Biotype	Recommended X-ray exposure			DAP (mGy*cm <sup>2</sup> )
		kV	mA	Exposure time (s)	
Child	Small	90.0	2.0	25.0	515.0
	Medium	90.0	2.5	25.0	643.8
	Large	90.0	3.2	25.0	824.0
Adult	Small	90.0	2.5	25.0	643.8
	Medium	90.0	3.2	25.0	824.0
	Large	90.0	4.0	25.0	1030.0

### HD 120kV Program

Type of patient	Biotype	Recommended X-ray exposure			DAP (mGy*cm <sup>2</sup> )
		kV	mA	Exposure time (s)	
Child	Small	120.0	5.0	20.0	990.0
	Medium	120.0	5.6	20.0	1108.8
	Large	120.0	6.3	20.0	1247.4
Adult	Small	120.0	6.3	20.0	1247.4
	Medium	120.0	7.1	20.0	1405.8
	Large	120.0	8.0	20.0	1584.0

### UHD 90kV Program

Type of patient	Biotype	Recommended X-ray exposure			DAP (mGy*cm <sup>2</sup> )
		kV	mA	Exposure time (s)	
Child	Small	90.0	2.0	25.0	515.0
	Medium	90.0	2.5	25.0	643.8
	Large	90.0	3.2	25.0	824.0
Adult	Small	90.0	2.5	25.0	643.8
	Medium	90.0	3.2	25.0	824.0
	Large	90.0	4.0	25.0	1030.0



UHD 120kV Program

Type of patient	Biotype	Recommended X-ray exposure			DAP (mGy*cm <sup>2</sup> )
		kV	mA	Exposure time (s)	
Child	Small	120.0	5.0	25.0	1237.5
	Medium	120.0	5.6	25.0	1386.0
	Large	120.0	6.3	25.0	1559.3
Adult	Small	120.0	6.3	25.0	1559.3
	Medium	120.0	6.3	25.0	1559.3
	Large	120.0	6.3	25.0	1559.3

9x9

LD 90kV Program

Type of patient	Biotype	Recommended X-ray exposure			DAP (mGy*cm <sup>2</sup> )
		kV	mA	Exposure time (s)	
Child	Small	90.0	2.0	10.0	268.0
	Medium	90.0	2.5	10.0	335.0
	Large	90.0	3.2	10.0	428.8
Adult	Small	90.0	2.5	10.0	335.0
	Medium	90.0	3.2	10.0	428.8
	Large	90.0	4.0	10.0	536.0

LD 120 Program

Type of patient	Biotype	Recommended X-ray exposure			DAP (mGy*cm <sup>2</sup> )
		kV	mA	Exposure time (s)	
Child	Small	120.0	5.0	10.0	645.0
	Medium	120.0	5.6	10.0	722.4
	Large	120.0	6.3	10.0	812.7
Adult	Small	120.0	6.3	10.0	812.7
	Medium	120.0	7.1	10.0	915.9
	Large	120.0	8.0	10.0	1032.0

STD 90 Program

Type of patient	Biotype	Recommended X-ray exposure			DAP (mGy*cm <sup>2</sup> )
		kV	mA	Exposure time (s)	
Child	Small	90.0	2.0	20.0	536.0
	Medium	90.0	2.5	20.0	670.0
	Large	90.0	3.2	20.0	857.6
Adult	Small	90.0	2.5	20.0	670.0
	Medium	90.0	3.2	20.0	857.6
	Large	90.0	4.0	20.0	1072.0

STD 120 Program

Type of patient	Biotype	Recommended X-ray exposure			DAP (mGy*cm <sup>2</sup> )
		kV	mA	Exposure time (s)	
Child	Small	120.0	5.0	15.0	967.5
	Medium	120.0	5.6	15.0	1083.6
	Large	120.0	6.3	15.0	1219.0
Adult	Small	120.0	6.3	15.0	1219.0
	Medium	120.0	7.1	15.0	1373.8
	Large	120.0	8.0	15.0	1548.0

HD 90kV Program

Type of patient	Biotype	Recommended X-ray exposure			DAP (mGy*cm <sup>2</sup> )
		kV	mA	Exposure time (s)	
Child	Small	90.0	2.0	25.0	670.0
	Medium	90.0	2.5	25.0	837.5
	Large	90.0	3.2	25.0	1072.0
Adult	Small	90.0	2.5	25.0	837.5
	Medium	90.0	3.2	25.0	1072.0
	Large	90.0	4.0	25.0	1340.0

HD 120kV Program

Type of patient	Biotype	Recommended X-ray exposure			DAP (mGy*cm <sup>2</sup> )
		kV	mA	Exposure time (s)	
Child	Small	120.0	5.0	20.0	1290.0
	Medium	120.0	5.6	20.0	1444.8
	Large	120.0	6.3	20.0	1625.4
Adult	Small	120.0	6.3	20.0	1625.4
	Medium	120.0	7.1	20.0	1831.8
	Large	120.0	8.0	20.0	2064.0

UHD 90 Program

Type of patient	Biotype	Recommended X-ray exposure			DAP (mGy*cm <sup>2</sup> )
		kV	mA	Exposure time (s)	
Child	Small	90.0	2.0	25.0	670.0
	Medium	90.0	2.5	25.0	837.5
	Large	90.0	3.2	25.0	1072.0
Adult	Small	90.0	2.5	25.0	837.5
	Medium	90.0	3.2	25.0	1072.0
	Large	90.0	4.0	25.0	1340.0

UHD 120 Program

Type of patient	Biotype	Recommended X-ray exposure			DAP (mGy*cm <sup>2</sup> )
		kV	mA	Exposure time (s)	
Child	Small	120.0	5.0	25.0	1612.5
	Medium	120.0	5.6	25.0	1806.0
	Large	120.0	6.3	25.0	2031.7
Adult	Small	120.0	6.3	25.0	2031.7
	Medium	120.0	6.3	25.0	2031.7
	Large	120.0	6.3	25.0	2031.7

## 9x16

### LD 120 Program

Type of patient	Biotype	Recommended X-ray exposure			DAP (mGy*cm <sup>2</sup> )
		kV	mA	Exposure time (s)	
Child	Small	120.0	5.0	10.0	645.0
	Medium	120.0	5.6	10.0	722.4
	Large	120.0	6.3	10.0	812.7
Adult	Small	120.0	6.3	10.0	812.7
	Medium	120.0	7.1	10.0	915.9
	Large	120.0	8.0	10.0	1032.0

### STD 120 Program

Type of patient	Biotype	Recommended X-ray exposure			DAP (mGy*cm <sup>2</sup> )
		kV	mA	Exposure time (s)	
Child	Small	120.0	5.0	15.0	967.5
	Medium	120.0	5.6	15.0	1083.6
	Large	120.0	6.3	15.0	1219.0
Adult	Small	120.0	6.3	15.0	1219.0
	Medium	120.0	7.1	15.0	1373.8
	Large	120.0	8.0	15.0	1548.0

### HD 120kV Program

Type of patient	Biotype	Recommended X-ray exposure			DAP (mGy*cm <sup>2</sup> )
		kV	mA	Exposure time (s)	
Child	Small	120.0	5.0	20.0	1290.0
	Medium	120.0	5.6	20.0	1444.8
	Large	120.0	6.3	20.0	1625.4
Adult	Small	120.0	6.3	20.0	1625.4
	Medium	120.0	7.1	20.0	1831.8
	Large	120.0	8.0	20.0	2064.0

UHD 120 Program

Type of patient	Biotype	Recommended X-ray exposure			DAP (mGy*cm <sup>2</sup> )
		kV	mA	Exposure time (s)	
Child	Small	120.0	5.0	25.0	1612.5
	Medium	120.0	5.6	25.0	1806.0
	Large	120.0	6.3	25.0	2031.7
Adult	Small	120.0	6.3	25.0	2031.7
	Medium	120.0	6.3	25.0	2031.7
	Large	120.0	6.3	25.0	2031.7

15x16

LD 120 Program

Type of patient	Biotype	Recommended X-ray exposure			DAP (mGy*cm <sup>2</sup> )
		kV	mA	Exposure time (s)	
Child	Small	120.0	5.0	10.0	645.0
	Medium	120.0	5.6	10.0	722.4
	Large	120.0	6.3	10.0	812.7
Adult	Small	120.0	6.3	10.0	812.7
	Medium	120.0	7.1	10.0	915.9
	Large	120.0	8.0	10.0	1032.0

STD 120 Program

Type of patient	Biotype	Recommended X-ray exposure			DAP (mGy*cm <sup>2</sup> )
		kV	mA	Exposure time (s)	
Child	Small	120.0	5.0	15.0	967.5
	Medium	120.0	5.6	15.0	1083.6
	Large	120.0	6.3	15.0	1219.0
Adult	Small	120.0	6.3	15.0	1219.0
	Medium	120.0	7.1	15.0	1373.8
	Large	120.0	7.1	15.0	1373.8

HD 120kV Program

Type of patient	Biotype	Recommended X-ray exposure			DAP (mGy*cm <sup>2</sup> )
		kV	mA	Exposure time (s)	
Child	Small	120.0	5.0	20.0	1290.0
	Medium	120.0	5.6	20.0	1444.8
	Large	120.0	5.6	20.0	1444.8
Adult	Small	120.0	5.6	20.0	1444.8
	Medium	120.0	5.6	20.0	1444.8
	Large	120.0	5.6	20.0	1444.8

UHD 120 Program

Type of patient	Biotype	Recommended X-ray exposure			DAP (mGy*cm <sup>2</sup> )
		kV	mA	Exposure time (s)	
Child	Small	120.0	4.5	25.0	1451.3
	Medium	120.0	4.5	25.0	1451.3
	Large	120.0	4.5	25.0	1451.3
Adult	Small	120.0	4.5	25.0	1451.3
	Medium	120.0	4.5	25.0	1451.3
	Large	120.0	4.5	25.0	1451.3

21x16

LD 120 Program

Type of patient	Biotype	Recommended X-ray exposure			DAP (mGy*cm <sup>2</sup> )
		kV	mA	Exposure time (s)	
Child	Small	120.0	5.0	10.0	645.0
	Medium	120.0	5.6	10.0	722.4
	Large	120.0	6.3	10.0	812.7
Adult	Small	120.0	6.3	10.0	812.7
	Medium	120.0	7.1	10.0	915.9
	Large	120.0	7.1	10.0	915.9

STD 120 Program

Type of patient	Biotype	Recommended X-ray exposure			DAP (mGy*cm <sup>2</sup> )
		kV	mA	Exposure time (s)	
Child	Small	120.0	5.0	15.0	967.5
	Medium	120.0	5.0	15.0	967.5
	Large	120.0	5.0	15.0	967.5
Adult	Small	120.0	5.0	15.0	967.5
	Medium	120.0	5.0	15.0	967.5
	Large	120.0	5.0	15.0	967.5

HD 120kV Program

Type of patient	Biotype	Recommended X-ray exposure			DAP (mGy*cm <sup>2</sup> )
		kV	mA	Exposure time (s)	
Child	Small	120.0	4.0	20.0	1032.0
	Medium	120.0	4.0	20.0	1032.0
	Large	120.0	4.0	20.0	1032.0
Adult	Small	120.0	4.0	20.0	1032.0
	Medium	120.0	4.0	20.0	1032.0
	Large	120.0	4.0	20.0	1032.0

UHD 120 Program

Type of patient	Biotype	Recommended X-ray exposure			DAP (mGy*cm <sup>2</sup> )
		kV	mA	Exposure time (s)	
Child	Small	120.0	3.2	25.0	1032.0
	Medium	120.0	3.2	25.0	1032.0
	Large	120.0	3.2	25.0	1032.0
Adult	Small	120.0	3.2	25.0	1032.0
	Medium	120.0	3.2	25.0	1032.0
	Large	120.0	3.2	25.0	1032.0

# 6

## CLEANING ,DISINFECTION AND STERILIZATION



## 6.CLEANING, DISINFECTION AND STERILIZATION



Before starting the cleaning and disinfecting procedure, turn off the main switch of the equipment to avoid permanent damage.



For your protection, during the process of cleaning and disinfecting the equipment use PPE as disposable gloves and goggles.

The cleaning and disinfection process of the unit must be performed at each change of patient. When starting the process, check for visible dirt, such as blood or saliva.

### CLEANING AND DISINFECTION

The following table summarizes standard cleaning and disinfection procedures to be performed by the operator.

Components	Cleaning and Disinfection Procedure
Handle	<b>a)</b> Prepare a 5% (v/v) neutral detergent solution with distilled water at a temperature between 35 and 65°C. <b>b)</b> Wear gloves during the entire cleaning process. <b>c)</b> Carry out the cleaning with a sterile gauze moistened in the detergent solution. <b>d)</b> Rub the gauze on the dirty area until the visible dirt is completely removed. <b>e)</b> If necessary, replace the gauze with a new one. <b>f)</b> Dry the item with a dry sterile gauze. <b>g)</b> Then moisten another sterile gauze with 20mL of 70% alcohol and rub the surface of the test item again. <b>h)</b> Wait for the total evaporation of the alcohol.
Chin mounting support	
Carpal support	
Nose support	
Head support	
Ear rods	
Main Control Panel	
Biteguide	<b>a)</b> Prepare a 5% (v/v) neutral detergent solution with distilled water at a temperature between 35 and 65°C. <b>b)</b> Pre-rinse devices by holding them under running, potable water for at least 30 (thirty) seconds. <b>c)</b> Fill a container with the detergent solution and deposit the devices. <b>d)</b> Devices must be completely submerged. Leave to act for at least 05 minutes. <b>e)</b> Rinse again with fresh, running water for at least 30 seconds. <b>f)</b> Use a brush with soft bristles to completely remove visible dirt. <b>g)</b> Repeat steps e) to h) if there are still traces of dirt. <b>h)</b> Dry the devices with a paper towel or gauze.. <b>i)</b> Moisten a sterile gauze with 20 ml of 70% alcohol and rub the surface of the devices again. <b>j)</b> Wait for the total evaporation of the alcohol.

## STERILIZATION

The following table summarizes the standard sterilization procedures to be performed by the operator.

Components	Sterilization Procedure
Biteguide	<b>a)</b> Place the components in their individual envelopes inside the autoclave. <b>b)</b> Select the sterilization cycle of 3 minutes at 135°C with a drying time of 30 minutes. <b>c)</b> Start the cycle according to the equipment's operating protocol. <b>d)</b> Perform at least 1 autoclave cycle to ensure proper sterilization.
Panoramic Chin rest for edentulous patient/ 3D positioner	
TMJ / Maxillary Sinus positioner	
Panoramic Chinrest for panoramic for toothed patient	



Up to 15,000 autoclaving cycles are allowed on each component, after this amount of cycles or a period of 10 years, new components must be purchased from the manufacturer.



Do not spill liquid disinfectant on the equipment.



Do not use organic solvents such as thinner to clean the equipment. In the event that developing solution is spilled on the panel, clean immediately as these solutions may compromise the painting of the equipment.



The sterilization parameters must always be following. Accessories that are not sterilized correctly can cause illness in patients.

# 7

## TROUBLESHOOTING

## 7.TROUBLESHOOTING

### 7.1.WARNING AND ERROR MESSAGES

Occasionally, malfunctions may occur during use. In the event of an error, an acoustic signal will be emitted by the equipment and an error message will be displayed on the software interface, whose detailed description is found in the service manual.

Restart the equipment and resume operation. If the problem persists, note the error displayed and contact your authorized service representative.

The following table lists the error indicated via acoustic signal.

Beep Code	Error Description
3 short beeps	General Error
5 short beeps	Exposure error

The detailed description of the error can be found in the service manual.

### 7.2.PROBLEM WITH UNIT OPERATION

Failures	Possible causes	Solutions
- Equipment will not turn on	- Power supply voltage not available	- Wait until the supply voltage is available
	- Cable not connected to equipment	- Connect the cable to the equipment
	- The plug is not connected to the network	- Connect the plug
	- Circuit breaker off	- Switch on the circuit breaker
	- ON / OFF Switch in the OFF position	- Place ON / OFF switch to the ON position
	- Fuse blown	- Replace fuse
- Digital image is not exhibited on the computer	- Cable disconnected	- Connect the cable to the equipment
	- Acquisition program with problem	- Reinstall the image acquisition program
	- Image acquisition button in program was not activated	- Activate the image acquisition button in program
- Remote exposure button does not work	- Remote exposure button cable is disconnected	- Connect the remote exposure button cable

### 7.3.PROBLEM WITH PATIENT POSITIONING

The standard panoramic radiography can be noted in the figure below:

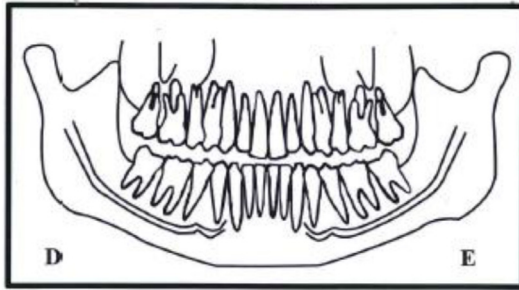

The patient positioning error may generate several failures in the image.

Failures	Possible causes	Solutions
- The teeth appear more amplified on one side and narrower on the other.	- Patient's head inclined. Patient's position inclined relation to the Mid-Sagittal plan.	- Check the position of the patient's sagittal plan with the laser line.

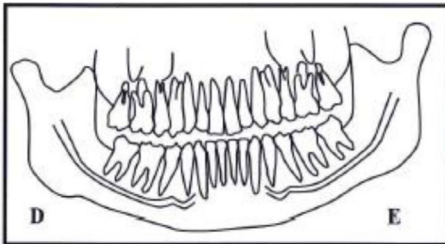

Head inclined to the right

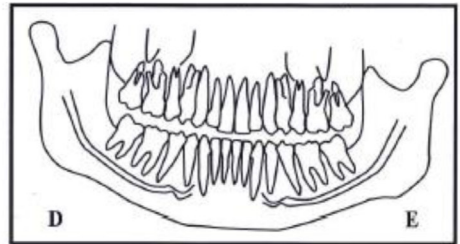

Head inclined to the left

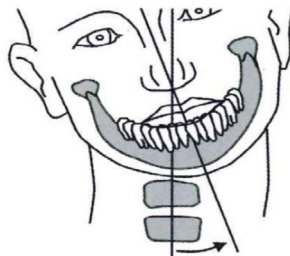

Failures	Possible causes	Solutions
- The teeth appear more amplified on one side and narrower on the other.	- The patient's head rotated Position of the patient for the posterior teeth in relation to the cut plan.	- Check the position of the patient's sagittal plan with the laser line.

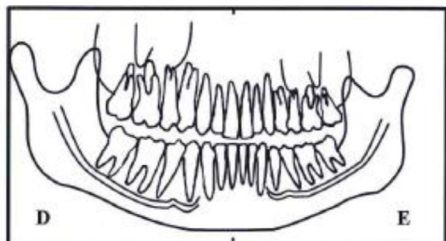

Head turned to the right

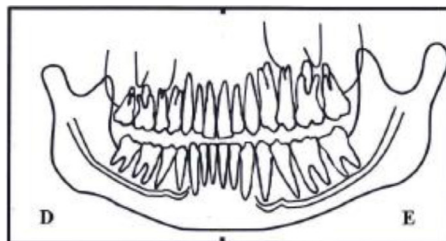

Head turned to the left

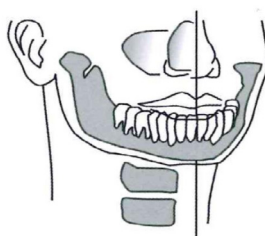

Failures	Possible causes	Solutions
- Incisors and canines narrow and deformed.	- Position of the anterior arcade to the focal plan.	- Adjust the focal plan of the equipment until the red laser is positioned over the Canine tooth.

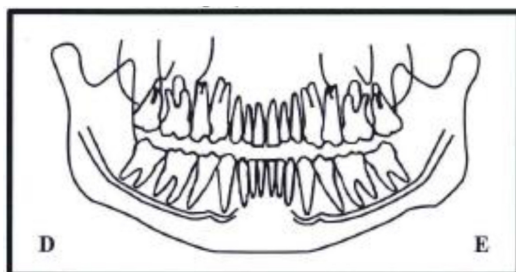

Failures	Possible causes	Solutions
- Incisors and canines large and deformed.	- Position of the posterior arcade to the focal plan.	- Adjust the focal plan of the equipment until the red laser is positioned over the Canine tooth.

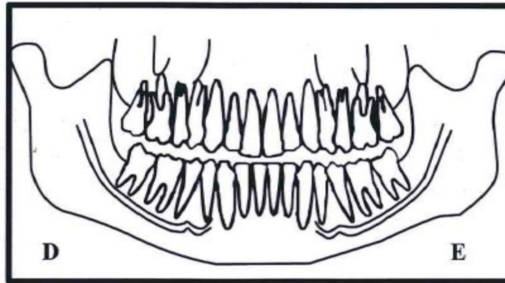

Failures	Possible causes	Solutions
- The row of teeth is curved upwards. The lower incisors are deformed. The joints of the TMJ are very high and are often cut from the image.	- The patient's head is leaning to the front.	- Reposition the patient based on the Frankfurt plan laser.

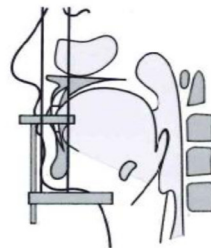
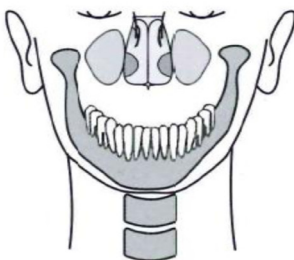
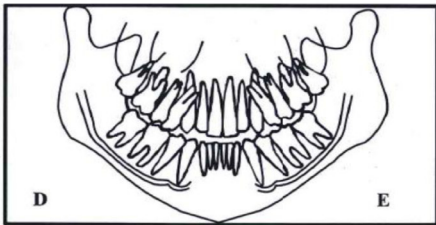

Failures	Possible causes	Solutions
- The row of teeth is plain. It is not possible to see the roots of the upper teeth.	- The patient's head is leaning backwards.	- Reposition the patient based on the Frankfurt plan laser.

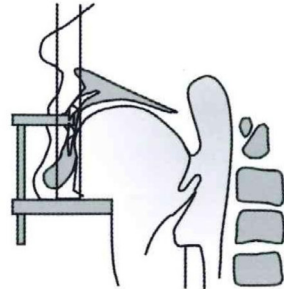
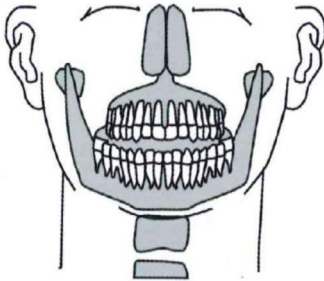
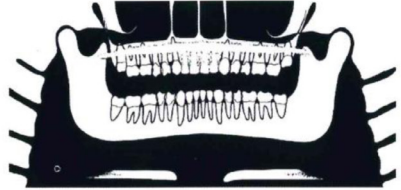
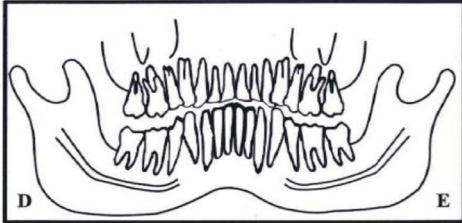



Failures	Possible causes	Solutions
<ul style="list-style-type: none"> <li>- Central area of image is very clear and deformed. Shadow of the column.</li> </ul>	<ul style="list-style-type: none"> <li>- The patient's neck is not stretched.</li> <li>- Contrast and brightness setting is incorrect in software.</li> </ul>	<ul style="list-style-type: none"> <li>- Ask the patient to step forward and stretch the neck.</li> <li>- Adjust contrast and brightness in software.</li> </ul>

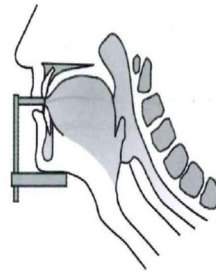
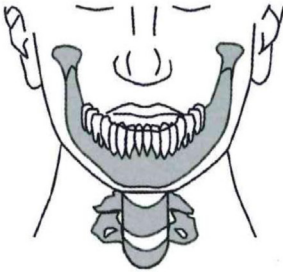
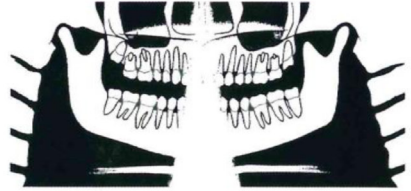
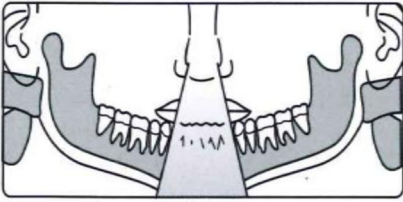

Failures	Possible causes	Solutions
- Incisors and canines blurry.	- Anterior teeth behind the focal plan. - Anterior teeth to the front of the focal plan.	- Adjust the cutting plan of the equipment until the red laser is positioned over the Canine tooth.

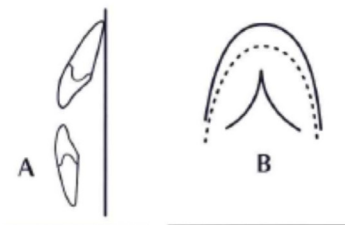
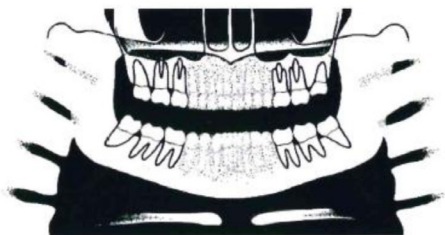

Anterior teeth behind the cutting plan

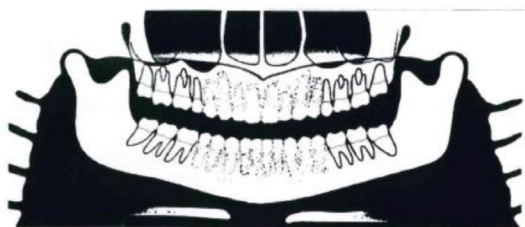

Teeth anterior to the front of the cutting plan

Failures	Possible causes	Solutions
- Upper arcade outside of image area.	- Chin not resting on the chinrest.	- Ask the patient to lean the chin on the chinrest.

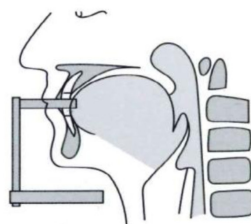
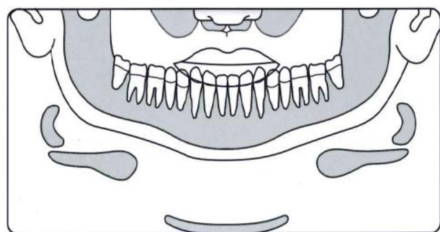

Failures	Possible causes	Solutions
- The patient's shoulders touch the X-ray head or the digital sensor.	- The patient is too big for the unit.	- Reverse the patient's hands on the bars: left on the right side and vice versa.
- The patient's nape touches the X-ray head.	- The leaning of patient's head is not correct.	- Check positioning of the head and reposition the patient.
	- The patient is too big for the unit.	- Ask the patient to bite to the front and adjust the equipment so that the red laser is positioned over the Canine tooth.
- It is not possible to see the lower edge of the cortical bone mandible in cross-sectional images.	- The leaning of the patient's head is not correct.	- Reposition the patient.
	- Patient without teeth (molar-premolar) bit in the molar region of the biteguide.	- Use cotton rolls with registration material and perform a new radiography.
- Rows of teeth overexposed.	- Tongue was not against the palate.	- Ask the patient to swallow and place the tongue against the palate.
- Ghost Images.	- Patient did not remove metal artifacts.	- Ask the patient to remove glasses, hearing aids, dental prostheses, and personal jewelry, such as earrings, necklaces, and hooks.

# 8

## QUALITY DIAGNOSES

## 8. QUALITY DIAGNOSES

This section will occasionally use procedures described in previous sections. Please refer to those sections when needed.

In order to assure image quality of the equipment, Quality Assurance (QA) Devices will be provided (Reference 21CFR 1020.33 (d)(1)) to test of the system performance and quality. These Devices were designed to provide maximum performance information with minimum effort.

During the installation or after a repair this QA procedure will create a baseline performance data. Make a periodic evaluation and compare with the baseline data.

If degradation in image quality or a change in QA values is noticed, contact the Alliage Service Department.

In order to perform the quality diagnoses, the user must log in into the control software and click on the QA Diagnosis icon at the home screen.

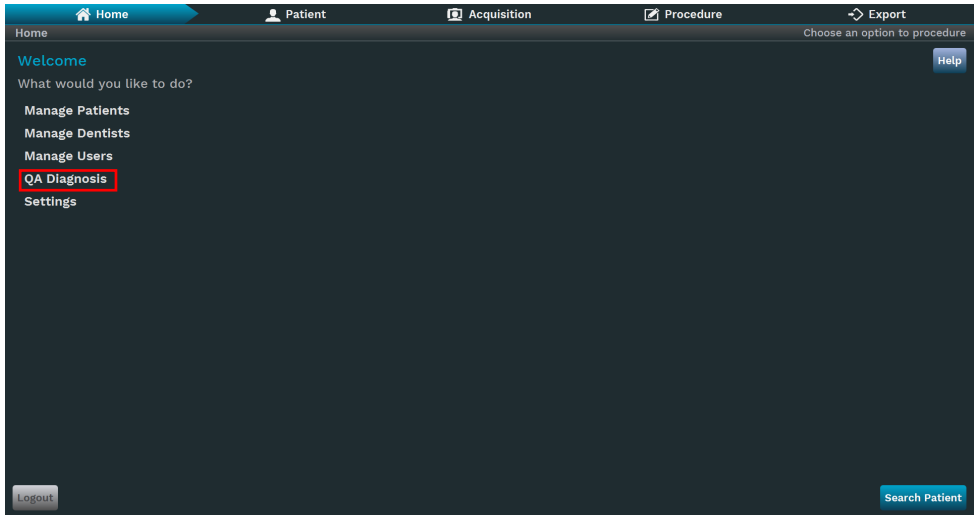

The following screen will be displayed:

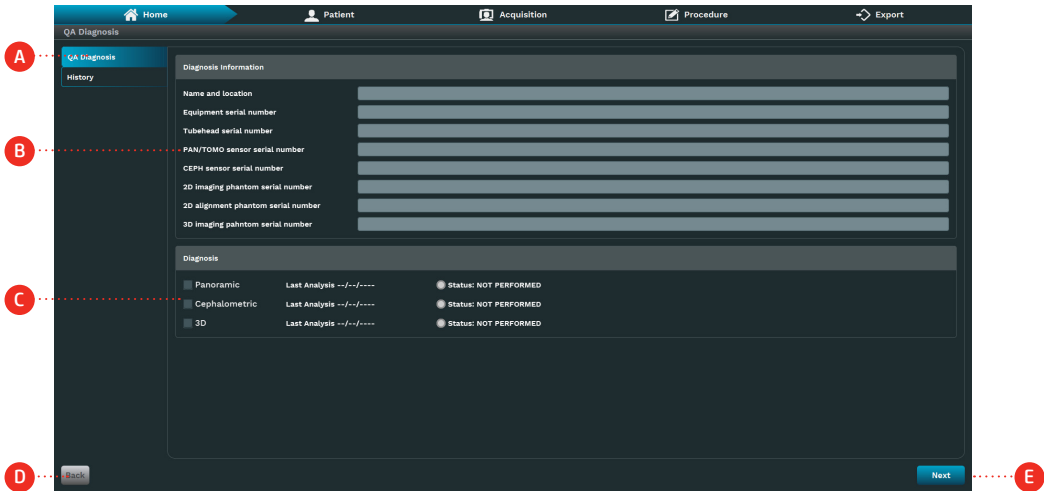

## Description

- A. QA Diagnosis: View the information and status of the QA tests.
- B. Test information: Enter the test registration information.
- C. QA Tests: View the date and status of the last test.
- D. Back: Return to the previous screen.
- E. Next: Perform the QA test.

Enter with the test registration information (B) and choose between the QA tests options (C) (Panoramic, Cephalometric and 3D).  
Click in Next (E). The software will display the capture screen with the acquisition parameters configured to perform the test.

## 8.1. PANORAMIC QUALITY DIAGNOSIS

For 2D images it will be validating the beam position, geometric calibration and the maximum contrast resolution. The QA Devices are show below.



QA Device for panoramic



QA Device for resolution test

### 8.1.1. Geometric calibration

The software will indicate that the calibration will be checked.  
Place the QA Device for Panoramic on chin rest support and level it.



QA Device for Panoramic

Make an exposure.

The software will measure in the image the geometric distance between all spheres, rotation and geometric form. It will indicate if the calibration is correct.

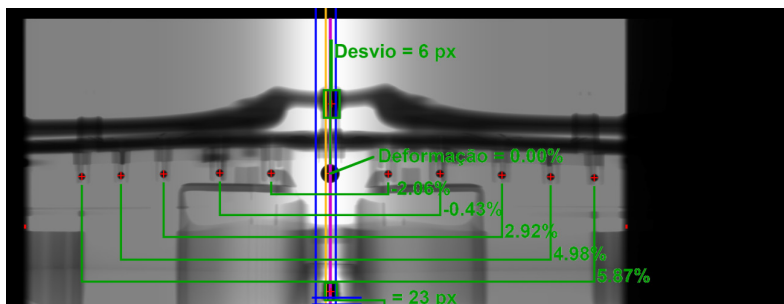

Calibration Check for Panoramic

### 8.1.2. Spatial resolution

The software will indicate that the spatial resolution will be checked. Remove the QA Device for Panoramic from the support, and place QA device for resolution test as shown below.



QA device for resolution test

Make an exposure.

The software will display the following image.

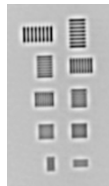

Check the image shown which lines of the image you can identify the separation.



## 8.2. CEPHALOMETRIC QUALITY DIAGNOSIS

### 8.2.1. Calibration

The software will indicate that the calibration will be verified.

Rotate the cephalostat and lock in the lateral cephalometric position. Perform an exposure, the software will present the radiographic image obtained.

Both ear rods have metal that appear in a clear way on the x-ray. The validation consists of verifying if the sphere is inside the circle as shown in the following picture bellow:

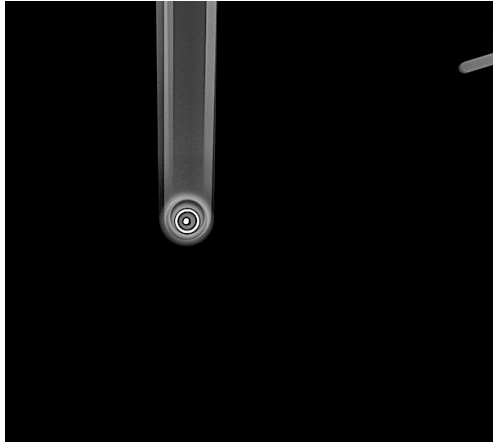

Calibration Check for Cephalometric

## 8.2.2. Spatial resolution

The software will indicate that the maximum contrast resolution will be checked. Remove the chin rest support, open the head holder. Rotate the cephalostat to lock at PA/AP position and open the ear rods. Place the QA device for resolution test at carpal support and place it at the cephalostat as shown below.



QA device for resolution test



Carpal support position

Make an exposure.

The software will display the following image.

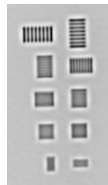

Check the image shown which lines of the image you can identify the separation.

### 8.3. TOMOGRAPHIC QUALITY DIAGNOSIS

For 3D exams, the software checks the density scale, image uniformity, artifacts, spatial resolution, and noise level. The quality device is shown below.

Position the CT QA device on top of the chin rest support. The cavity indicated in the image must be filled with water.

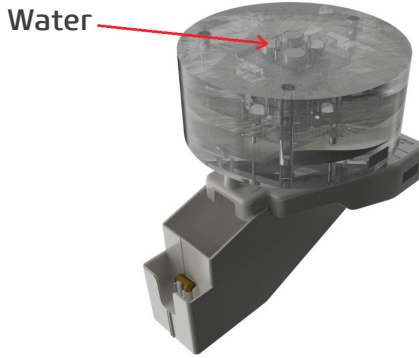

CT QA device

The CT QA device consists of three cylindrical sections designed to measure all imaging parameters with as few exams as possible. Layers are described in the image below.

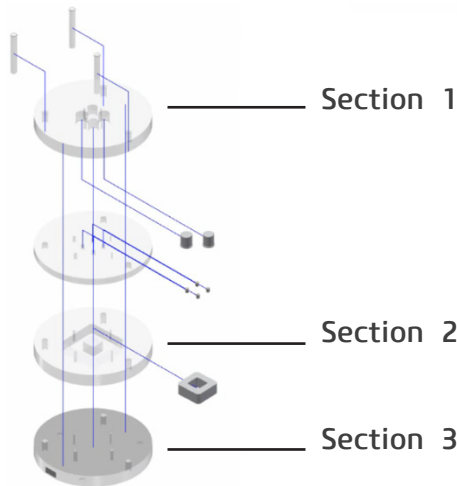

### 8.3.1. Contrast scale

CT numbers, also called Hounsfield Units (HU), represent the values of attenuation of the passage of X-rays through a variety of material densities.

Section 1 of the calibration device has two cavities. One cavity is a hole with air, and the other cavity must be filled with water.

The software measures these two cylindrical Regions of Interest (ROIs) and calculates the average values for each of the two materials (Water and Air).

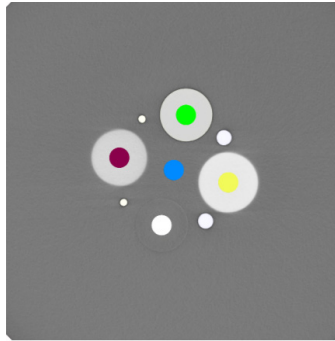

Hounsfield validation

The CT values of water and air referring to the image of the tomographic quality diagnostic device will be used to assess the density scale over time.

### 8.3.2. Slice thickness

For this evaluation, the software will use Section 2 of the tomographic quality diagnostic device, performing a scan on the axial slices of the volume to verify the actual size of the voxel. During the sweep, the initial and final axial cut of the volume of the square object made of PVC, positioned in the center of the cylinder, will be identified. Once you know the real height of this object in millimeters and the height measurement in voxels, the real size of the image's slice thickness will be calculated.

### 8.3.3. Spatial resolution

The modulation transfer function (MTF) mathematically quantifies the contrast resolution. MTF measures preserved contrast for a sine wave pattern as a function of spatial frequency. An MTF curve starts at 1 for zero frequency and decreases as the spatial frequency increases. Threshold resolution is equal to the frequency at which the MTF drops to 0. The measure of frequency is in pairs of lines per millimeter.

For the calculation of the MTF, the software will use the Slanted-Edge technique, which is an edge gradient MTF method specifically suited for calculations using spatially sampled capture devices.

For this evaluation, the software will use Section 2 of the tomographic quality diagnostic device. The identification of the spatial resolution will be made from the transition of gray levels provided by the PVC piece fitted in the center of the cylinder. Air and PVC will create a black-white contrast of the slanted edge.

Using the generated image, the software will select a rectangular region of interest (ROI) around the black-white transition of the slanted edge.

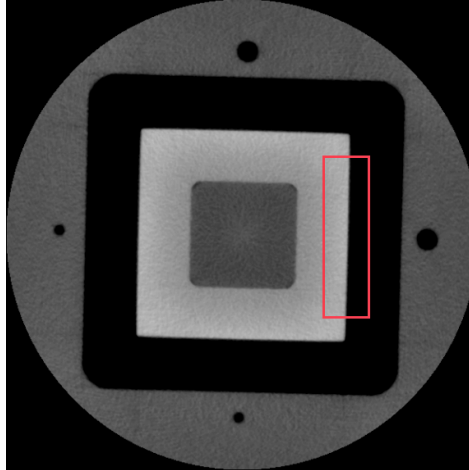

Black-white PVC/air slanted edge transition.

From the image, the Spatial Frequency Response (SFR) is calculated. The line propagation function (LSF) is generated by numerically calculating the first derivative of the SFR. Once the LSF is known, the magnitude of the FFT of this LSF is calculated. A graph of the relationship between the magnitude of the FFT versus the spatial frequency resulting in the MTF will be generated.

### 8.3.4. Uniformity

The aim of this analysis is to evaluate the uniformity of voxels within this region of homogeneous material. Section 3 of the device is a uniform region of acrylic. The software selects 5 ROIs and measures the pixel values within these ROIs, calculating the mean value and standard deviation for each ROI.

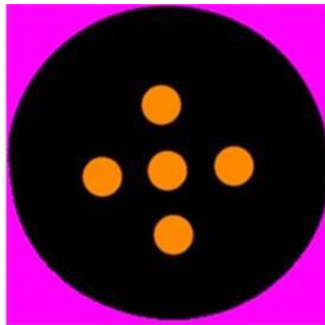

Noise and Uniformity Section

### 8.3.5. Noise

Using Section 3 of the tomographic quality diagnostic device, the software evaluates the noise behavior in the middle of the image. For this, the standard deviation of the gray levels of the voxels of a cylindrical ROI centered on a uniform region of acrylic is calculated, divided by the difference between the mean values of the CT number of acrylic and air.

### 8.3.6. Low contrast detectability

Low contrast detectability (LCD) measures the ability of a CT scanner to differentiate a low contrast object from its background. The visibility of objects depends on the size and contrast level of the background. As the size of these objects decreases, it becomes more difficult to recognize them for the same contrast level.

To determine the LCD, the software will use the uniform region of Section 3 of the tomographic quality diagnostic device. The central region of this slice is divided into several circular ROIs of the same diameter. The mean voxel value of each ROI is calculated and the standard deviation of the means is obtained. The contrast of an object the same size as these ROIs is defined as 3.29 times the standard deviation to be differentiated from the background. This analysis is repeated with different ROI sizes and a contrast detail diagram is created in the report.

## 8.4. DOSE MEASUREMENT

For periodic dose measurement, a radiation detector should be used to measure Kerma in air.

Configure the exposure parameters (kV, mA and Time) in the software. Position the radiation detector at the tube outlet and perform an exposure.

Access the dose measurement tool in the software and enter the exposure parameter values and measured air kerma to generate a report that can be saved to compare the results with previous or optimal values.

## 8.5. QA REPORT

After diagnosis, the software will create a quality control report that can be saved to compare results with previous or reference values.

# 9

## INSPECTION AND MAINTENANCE

## 9.INSPECTION AND MAINTENANCE



Maintenance or servicing may only be carried out by a service technician authorized by the manufacturer.

All instructions for using the equipment as intended are provided in this user guide. If any problems are detected and cannot be corrected with the instructions in the error diagnoses section, contact the Alliage Service Department.

### 9.1.PERIODIC INSPECTION

It is extremely important that this equipment be inspected regularly to ensure operational security and functional reliability.

This inspection should be carried out by professionals familiar with the necessary precautions in order to avoid excessive exposure to both primary and secondary radiation. This equipment has a protection to limit both the primary and secondary radiation produced by the X-ray beam. However, such protection cannot prevent carelessness, negligence or lack of knowledge.

Periodic inspection should be performed at regular intervals (at least once a year) to ensure that the product is permanently safe and operational. All components subject to normal wear and tear should be checked and, if necessary, replaced.

The manufacturer and the installer are exempt from liability if the standard results are not in conformity in cases where the user does not perform the maintenance recommended by the manufacturer.

Neither the inspection nor the service is part of the equipment warranty. The maintenance performed should be documented and maintained with the equipment.



The following table gives a description of the main inspection items and recommended frequency.

Item	Inspection description	Recommended frequency*
Security system	Collision, Warning Lights, and Interlock	Daily
Internal and external exposure button	Operation	Daily
Electrical parts	Overheating / Noise / Burning smell	Monthly
Cooler	Operation/Noise/Burning smell	Monthly
Digital sensor	Communication/Operation/Overheating	Monthly
Head	Operation /Noise/Overheating/Oil leakage	Monthly
Quality diagnosis	Performance	Monthly
Column	Operation/Noise/Vibration	Annual
Chin support	Operation/Noise/Vibration	Annual
Movement mechanism	Operation/Noise/Vibration	Annual
Membrane keyboard	Operation/Damage	Annual
Laser	Operation/Intensity	Annual
Accessories	General damages that may cause a risk	Annual
Dose measurement <sup>1</sup>	Performance	Annual

\* ICRP Publication 129 agreement recommendation

<sup>1</sup> Refer to the procedures described in Dose Measurement in Quality Diagnoses









Periodic inspections must be documented and maintained with the equipment.  
If problems are detected during the inspection, contact the Alliage Service Department.

## 9.2.PREVENTIVE MAINTENANCE

In addition to the annual inspection, to ensure long durability and correct operation of your equipment, it is important to perform the preventive maintenance within a maximum period of three (3) years. Contact the Alliage Service Department as related to our periodic inspection and preventive maintenance program.

Preventive maintenance performed must be documented and maintained with the equipment.

### 9.3.CORRECTIVE MAINTENANCE

	<p>For repair or replacement of any part or piece of equipment refer to the instructions in the service manual.</p>
	<p>The corrective maintenance cannot be performed by the user. Do not open the device or try to convert it yourself or with the help of someone without training or authorization. This may aggravate the problem or produce a failure that may compromise the security of the equipment.</p>
	<p>Power cables, electronic boards, fuses and rotating belts may only be replaced by authorized service personnel. See service manual for connection and anchoring information.</p>
	<p>Dental CT Scanner AXR or any parts thereof may not be serviced or assisted during use with a patient.</p>
	<p>Equipment contains parts under high voltage. Risk of electric shock. Turn off the main switch before servicing.</p>
	<p>Part movable can cut or crush.</p>
	<p>Keep hands away from the rotation belts, Risk of entanglement.</p>
	<p>This equipment can not be tilted more than 5°. Risk of tipping.</p>
	<p>The service manual is available only to Authorized Technical Assistance.</p>

Alliage declares that the supply of circuit diagrams, component lists or any other information that provides technical assistance on behalf of the user, can be requested provided that it is previously agreed between the user and the Alliage Company.

Warranty will be void if original parts are removed / replaced by unauthorized service technicians.

### **9.4.ALLIAGE AUTHORIZED SERVICE NETWORK**

All services performed on Alliage equipment should be performed by an Authorized Technical Assistance, otherwise they will not be covered by the warranty.

If you need to order wiring diagrams and / or component specifications that are not indicated in the user manual, please use Alliage Customer Service to complete the request.

Phone: +55 (16) 3512-1288

Address: Rodovia Abrão Assed, Km 53 - Recreio Anhangüera  
Ribeirão Preto-SP – Brazil - CEP - 14097-500

# 10

**WARRANTY**

Alliage S/A Industrias Médico Odontológica  
Telephone: +55 (16) 3512-1212  
Rodovia Abrão Assed, Km 53 – CEP 14097-500 –Ribeirão Preto – SP –Brazil

## **10.WARRANTY**

This equipment is covered by the warranty terms, terms and conditions contained in the Warranty Certificate that accompanies the product.

## STANDARDS AND REGULATIONS

## 11. STANDARDS AND REGULATIONS

This equipment was designed and manufactured to meet the following standards:

EN 60601-1:2006/A1:2013	Medical Electrical Equipment - Part 1: General requirements covering basic security and essential performance.
EN 60601-1-2:2015/A1:2021	Medical Electric Equipment, Part 1-2: General requirements for basic safety and essential performance - Collateral standard; Electromagnetic Interferences - Requirements and tests.
EN 60601-1-6:2011/A2:2021	Medical Electric Equipment, Part 1-6: General Requirements for Basic Security and Essential Performance - Collateral Standard: Usability.
EN 60601-1-9:2008/A2:2020	Medical electrical equipment - Part 1-9; General requirements for basic safety and essential performance - Collateral standard; Requirements for conscious environmental project
EN 60601-1-3:2008/A2:2021	Medical Electric Equipment, Part 1-3: General requirements for basic safety and essential performance - Collateral standard; Radiation protection on diagnostic X-ray equipment.
EN 60601-2-63:2015/A2:2021	Medical Electrical Equipment - Part 2-63: Specific requirements for basic safety and essential performance of extra oral dental x-ray equipment.
EN 62304:2006/A1:2015	Medical Device Software - Software Life cycle Processes.
EN 62366-1:2015/A1:2020	Medical devices Application of usability engineering to medical devices
EN ISO 10993-1:2020	Biological evaluation of medical devices - Part 1: Evaluation and tests.
EN 60825-1:2014/A11:2021	Laser Product Safety - Part 1: Classification and Equipment Requirements
EN ISO 15223-1:2021	Graphic symbols for electrical equipment in medical practice
EN 20417:2021	Information provided by manufacturer of medical devices.
EN ISO 13485:2016	Quality management systems - Requirements for regulatory purposes
EN ISO 14971:2019/ A11:2021	Medical Devices - Application of risk management to medical devices.
21 CFR 1020.30	Diagnostic X-ray systems and their main components.
21 CFR 1020.31	Radiographic equipment
21 CFR 1020.33	Computed tomography (CT) equipment
ANSI / AAMI ES60601-1:2005 / (R) 2012 and A1:2012, C1:2009/ (R) 2012	Medical electrical equipment - Part 1: General requirements for basic safety and essential performance;
CAN / CSA-C22.2N° 60601-1:14	Medical Electrical Equipment - Part 1: General Requirements for Basic Safety and Essential Performance;

## TECHNICAL SPECIFICATIONS



## 12. TECHNICAL SPECIFICATIONS

### 12.1. EQUIPMENT CLASSIFICATION

#### EQUIPMENT CLASSIFICATION

Type of classification according to ANVISA	Class III
--	-----------

Type of classification according to CE/FDA	Class IIb
--	-----------

#### CLASSIFICATION OF EQUIPMENT ACCORDING TO STANDARD EN IEC 60601-1

Classification per product for applied parts	Type B
--	--------

Protection against Electric Shock	Class I
-----------------------------------	---------

Protection against Harmful Penetration of Water	IP00 - Product not protected against harmful penetration of water and particulate material
---	--

Degree of safety of application in presence of a flammable anesthetic mixture with air, oxygen or nitrous oxide	Equipment not adequate
---	------------------------

Operation Mode	Non-continuous operation Exposure time: T on: 25 s / T off: 3 min
----------------	---

Column Operation Time: T.on: 1 min. / T.off: 9 min.
--

Note: If the temperature inside the tubehead reaches 55° C, exposure to X-rays will be interrupted and a message will be displayed. The exposure will be enabled again after the internal temperature of the generator reaches 54.5° C.

## 12.2.DEVICE INFORMATION

GENERAL INFORMATION	
Mains voltage	110/127/220/240 V~
Power supply frequency	50 /60 Hz
Allowable fluctuation	+/- 10 %
Number of phases	Monophasic/Biphasic
Rated current in standby	600mA -110/127V 400mA -220/240V
Rated current during emission	15A (máx) -110/127V 7.5A (máx) -220/240V
Master key	Single pole More than 100000 cycles 20A / 250 VAC
Input fuses	T20A H 250 V (110/127V~) T10A H 250 V (220/240V~)
Power Consumption	1.7 kVA
Maximum network impedance	0.2Ω
Head support (full load)	9.8kg (support) + 5kg (head)
Net weight without cephalostat	125 kg
Net weight with cephalostat	160 kg
Net weight of X-ray generator	14.3 kg
Height adjustment of the column	820 mm
Maximum height of the product	2392 mm
Dental CT Scanner AXR for dental extra-oral radiography models AXR90 and AXR120 EN 60601-2-63:2015/A2:2021.	

POSITIONING LASER	
Class	Class 1
Power	< 1mW
Wave length	650nm

12.3.RADIOLOGIC INFORMATION

GENERAL INFORMATION		
Model	AXR90	AXR120
Ampoule voltage	60 - 90 kV (at 90kV max. 12.5mA)	60 - 120 kV (at 120kV max. 8mA)
Ampoule current	1.8 – 16 mA ( at 16mA max. 70kV)	
Maximum energy accumulated in 1 hour	1120 mAs.	
Maximum Work Factor	1 : 25s	

ACCURACY OF LOAD PARAMETERS	
Voltage (Kvp)	± 10 %
Anode current (mA)	± 20 %
Time of application of load (s)	± 5 % + 50 ms

SPECIFIC INFORMATION FOR PANORAMIC RADIOGRAPHY PROGRAMS	
Exposure time	Standard: 14s Fast Panoramic: 10s Improved orthogonality: 14s Infant: 10s Maxillary sinus: 8s TMJ: 10s TMJ PA: 10s Bitewing: 7.6s Lateral section (left or right): 6s Center section: 3.5s
Emission voltage / Anode current of exposures	60~70kV _ 3.2~16.0mA 72.5~80kV _ 3.2~14.0mA 82.5~90kV _ 3.2~12.5mA
Distance focus - film	620 mm

SPECIFIC INFORMATION FOR CEPHALOMETRIC RADIOGRAPHY PROGRAMS	
Exposure time:	AP/PA, LL, Carpal, Oblique: from 4.1 to 16.5s Fast Mode: from 2.5 to 10s
Emission voltage/Anode current of exposures	60~70kV _ 3.2~16.0mA 72.5~80kV _ 3.2~14.0mA 82.5~90kV _ 3.2~12.5mA
Distance focus - film	1732.5 mm

SPECIFIC INFORMATION FOR TOMOGRAPHIC RADIOGRAPHY PROGRAMS		
Model	AXR90	AXR120
Exposure time	Fast Scout: 0.1s Full Scout: 0.2s Low Dose: 10s Standard: 20s High Definition: 25s Ultra High Definition: 25s	Fast Scout: 0.1s Full Scout: 0.2s Low Dose: 10s Standard: 15s High Definition: 20s Ultra High Definition: 25s
Emission voltage/Anode current of tomography exposures.	Fast Scout: 90kV - 4mA	Fast Scout: 120kV - 8mA
	Full Scout: 90kV - 4mA	Full Scout: 90kV - 8mA
	Low Dose: 90kV_1.8~4mA	Low Dose: 120kV_3.2~8.0mA
	Standard: 90kV_1.8~4mA	Standard: 120kV_3.2~8.0mA
	High Definition: 90kV_1.8~4mA	High Definition: 120kV_3.2~8.0mA
	Ultra High Definition: 90kV_1.8~4mA	Ultra High Definition: 120kV_3.2~6.3mA

12.4.X-RAY GENERATOR

GENERAL INFORMATION		
Model	AXR90	AXR120
Type of generator	Constant Frequency High Frequency Generator	
Type and nature of radiation	X-ray ionizing wave	
Operation frequency	Variable	
Maximum operation voltage	90kVp	120 kVp
Heating and Cooling Curve	See graph covering head cooling characteristics	
Power at maximum output	1125 W (90kV x 12.5mA)	
Power at maximum output for 0.1s.	1125 W (90kV x 12.5mA)	
Permanent filtration	> 2.5mm Al eq. @ 70kVp	
Additional filtration	1.5mm Al + 0.1mm Cu	1.5mm Al + 0.7mm Cu
Filtration of fixed layer of material of the covers	< 0.2 mm Al eq. @70kVp	
Total filtration	> 3.25mm Al eq. @ 90kVp	> 4.35mm Al eq. @ 120 kVp
Radiation leak	< 0.88 mGy/h @ 70kV. 16mA	
Target angle	Tube Model D-054SB: 5° Tube Model D-023SB: 10°	Tube Model D-059SBR: 5°
Focal spot as specified in IEC 60336, measured in the central X-ray beam:	Tube Model D-054SB: 0.5 x 0.5 mm  Tube Model D-023SB: 0.2 x 0.2 mm	Tube Model D-059SBR: 0.5 x 0.5 mm
Reference axis	In the center of the active area of the sensor	
The X-Ray Generator is manufactured and assembled by Alliage S/A Industrias Médico Odontológica.		
The Dental CT Scanner AXR with protection against according to EN 60601-1-3:2008/A2:2021		



The equipment emits ionizing radiation only when a high voltage is applied by the x-ray generator.

Figure 1 - Characterization of x-ray emitter

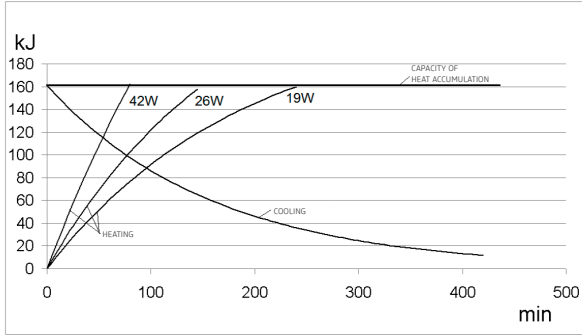

12.5.X-RAY TUBE

DESCRIPTION	MODELS		
	AXR90		AXR120
Equipment model	AXR90		AXR120
Manufacturer	CANON	CANON	CANON
Model	D-054SB	D-023SB	D-059SBR
Operation voltage	50 ~100 kVp	100 kVp	60 ~120 kVp
Size of focus	0.5mm	0.2mm	0.5mm
Tolerance of focal point position	+/- 1mm	+/- 1mm	+/- 1mm
Angle of anode	5°	10°	10°
Equivalent filtering	0.8 mm Al equiv. @ 50kV	0.8 mm Al equiv. @ 75kV	0.8 mm Al equiv. @ 50kV
Material of anode	Tungsten	Tungsten	Tungsten
Anode input power	1750W	387W	1300W
Thermal capacity	35 kJ	35 kJ	28 kJ
Maximum thermal capacity and cooling curve	See graph of thermal characteristics of the anode	See graph of thermal characteristics of the anode	See graph of thermal characteristics of the anode
Maximum current	22 mA	4.3 mA	20 mA
Maximum filament current	3.5A / 4.2V	3.9A / 1.87-2.53V	(3.5A) / 3.4~4.9V
Frequency	Direct current Continua	Direct current Continua	Direct current Continua
Maximum Exposure time	20s	40s	25s
Maximum Continuous Thermal Dissipation	250 W	250 W	250 W
Filament limiting frequency	0~20kHz	0~20kHz	0~20kHz

Emission and filament characteristics

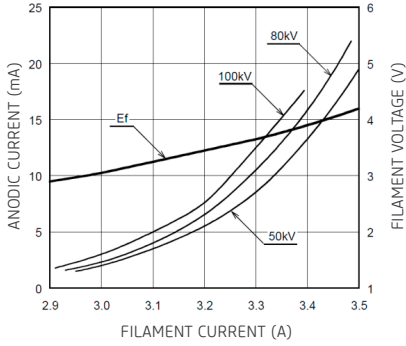

D-054SB

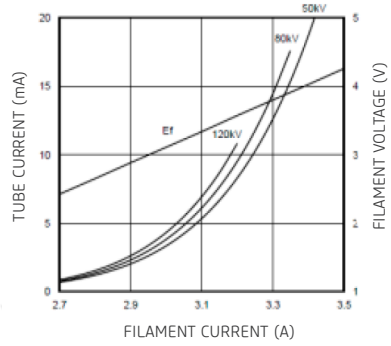

D-059SBR

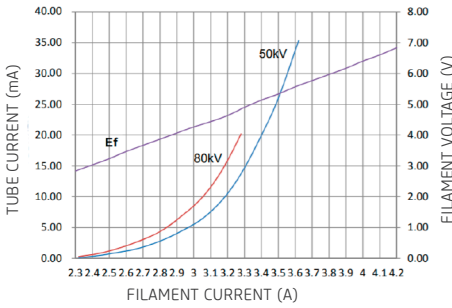

KL29-0.5-100

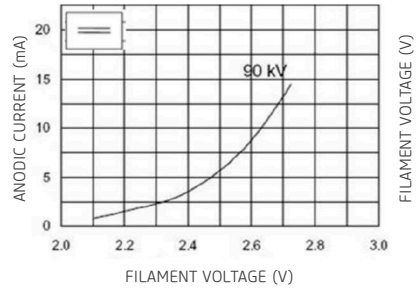

KL3-0.5-130

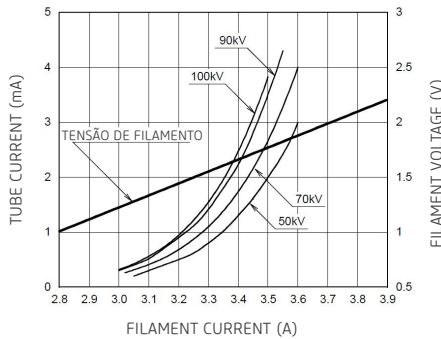

D-023SB



Maximum load graphs

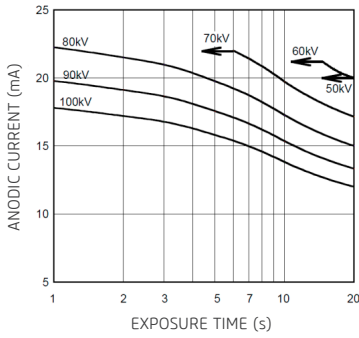

**D-054SB**

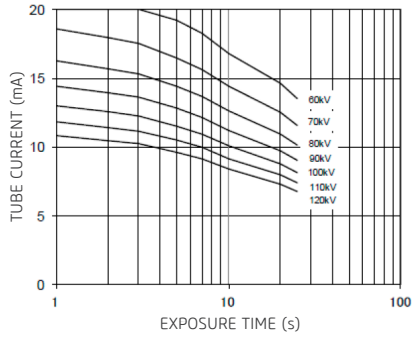

**D-059SBR**

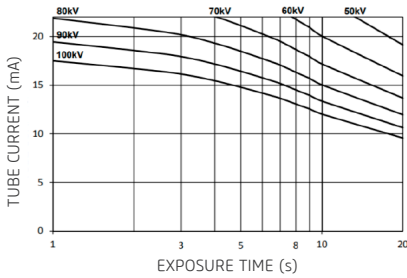

**KL29-0.5-100**

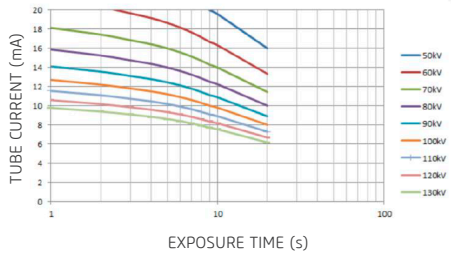

**KL3-0.5-130**

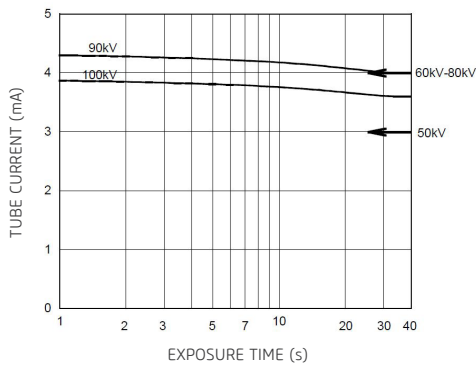

**D-023SB**

Thermal characteristics of the anode

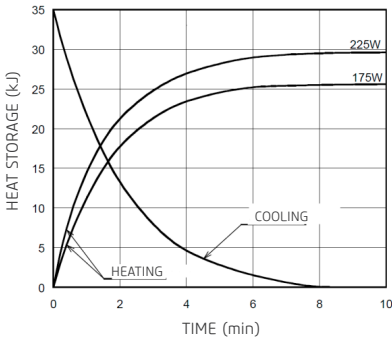

D-054SB

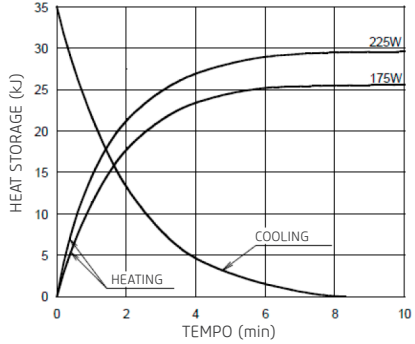

D-059SBR

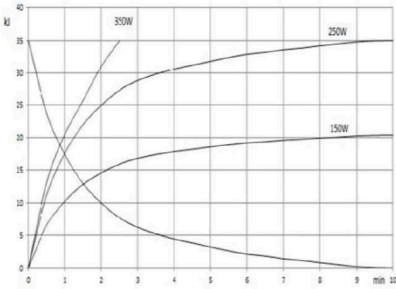

KL29-0.5-100

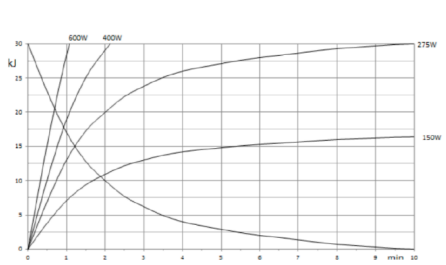

KL3-0.5-130

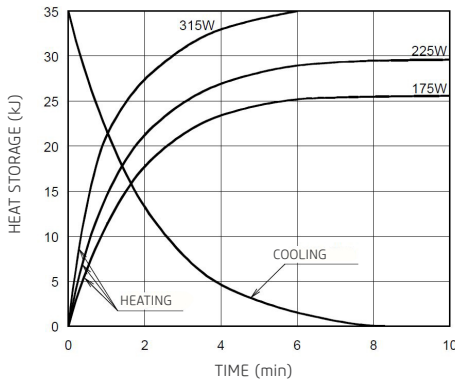

D-023SB



The X-ray Tubes are for EXCLUSIVE use of the Dental CT Scanner AXR.

## 12.6.SENSOR CHARACTERISTICS

SENSOR 2D - PAN ONLY		
Model	SPB PAN	XINEOS 1501
Manufacturer	Alliage	Teledyne Dalsa
Type of sensor	CMOS	CMOS
Active area (mm)	157.5x6.4	152x6.5
Pixel size (µm)	100	99

SENSOR 2D – PAN/CEPH		
Model	SPB CEPH	XINEOS 2301
Manufacturer	Alliage	Teledyne Dalsa
Type of sensor	CMOS	CMOS
Active area (mm)	220.5x6.4	228x6.5
Pixel size (µm)	100	99

SENSOR 3D	
Model	VIVIX-D 0606C
Manufacturer	Vieworks
Type of sensor	CMOS/a-Si
Active area (mm)	152.32 x 152.32
Pixel size (µm)	119 µm



For this tomography equipment it is not possible to use a focus distance greater or less than that obtained with the correct positioning of the patient, as it compromises the quality of the generated image.

## 12.7.IMAGE MAGNIFICATION

EXAM	SOURCE-IMAGE DISTANCE (SID)	SOURCE-OBJECT DISTANCE (SOD)	MAGNIFICATION FACTOR
Panoramic/ Tomography	620 mm	400 mm	1.55
Cephalometric	1732.5 mm	1473.65 mm	1.17

**12.8.ENVIRONMENTAL CONDITIONS**

<b>ENVIRONMENTAL CONDITIONS FOR TRANSPORTATION AND STORAGE</b>	
Range of transportation or storage environment temperature	-18°C a +70°C
Range of relative humidity for transportation and storage	< 90% RH
Range of atmospheric pressure	700 hPa - 1060 hPa (525 mmHg - 795 mmHg)

<b>ENVIRONMENTAL CONDITIONS FOR INSTALLATION AND OPERATION</b>	
Range of operation environment temperature	+10°C a +35°C
Range of relative humidity for operation (not condensed)	< 75% RH
Range of atmospheric pressure	700 hPa - 1060 hPa (525 mmHg - 795 mmHg)
Operation altitude	≤ 2000 m

## ELECTROMAGNETIC COMPATIBILITY

### 13.ELECTROMAGNETIC COMPATIBILITY

The Dental CT Scanner AXR is intended for use in the electromagnetic environment specified below. It is recommended that the buyer or the user ensures that it is used in such an environment.

The Dental CT Scanner AXR is suitable for use in a professional health care environment, not including areas where there are sensitive equipment or sources of intense electromagnetic disturbances, such as the RF shielded room of an imaging system magnetic resonance imaging, in operating rooms near active AF surgical equipment, electrophysiology laboratories, armored rooms or areas where short wave therapy equipment is used.

The following tables provide equipment compliance information with EN 60601-1-2:2015/A1:2021.

#### 13.1.GUIDANCE AND DECLARATION FOR ELECTROMAGNETIC EMISSIONS

EMISSION ESSAYS	CONFORMITY	ELECTROMAGNETIC ENVIRONMENTS - GUIDELINES
CISPR 11 RF Emissions	Group 1	The Dental CT Scanner AXR uses RF energy only for its internal functions. Therefore, your RF emissions are very low and probably will not cause any interference in nearby electronic equipment.
CISPR 11 RF Emissions	Class A	Dental CT Scanner AXR is suitable for use in all establishments other than domestic and those directly connected to the public low-voltage power supply network that supplies buildings used for domestic purposes.
Harmonic emissions IEC 61000-3-2	Class A	
Voltage fluctuation/ Scintillation emissions IEC 61000-3-3	Compliance	

**Note:** The emission characteristics of this equipment make it suitable for use in industrial and hospital areas (IEC / CISPR 11, Class A). If used in a residential environment (for which IEC / CISPR 11, Class B is normally required), this equipment may not provide adequate protection for radio communications services. The user may need to take mitigation measures such as relocating or reorienting the equipment.

### 13.2.GUIDANCE AND DECLARATION FOR ELECTROMAGNETIC IMMUNITY

PHENOMENON	BASIC STANDARD OF EMC OR TEST METHOD	IMMUNITY TEST LEVEL	LEVEL OF CONFORMITY
Electrostatic discharge	IEC 61000-4-2	± 8 kV contact ± 2 kV, ± 4 kV, ± 8 kV, ± 15 kV air	± 8 kV contact ± 2 kV, ± 4 kV, ± 8 kV, ± 15 kV air
Radiated RF EM fields	IEC 61000-4-3	3 V / m 80 MHz - 2.7 GHz 80% AM at 1 kHz	3 V / m 80 MHz - 2.7 GHz 80% AM at 1 kHz
Proximity fields from RF wireless communications equipment	IEC 61000-4-3	As shown in the table below	As shown in the table below
Electrical fast transients/bursts	IEC 61000-4-4 Input a.c. power port	± 2 kV 100 kHz repetition frequency	± 2 kV 100 kHz repetition frequency
	IEC 61000-4-4 Signal input/output parts port	± 1 kV 100 kHz repetition frequency	± 1 kV 100 kHz repetition frequency
Surges Line-to-line	IEC 61000-4-5	± 0,5 kV, ± 1 kV	± 0,5 kV, ± 1 kV
Surges Line-to-ground	IEC 61000-4-5	± 0,5 kV, ± 1 kV, ± 2 kV	± 0,5 kV, ± 1 kV, ± 2 kV
Conducted disturbances induced by RF fields	IEC 61000-4-6	3 V m 0.15 MHz – 80 MHz 6 V in ISM bands Between 0.15 MHz and 80 MHz 80 % AM at 1 kHz	3 V m 0.15 MHz – 80 MHz 6 V in ISM bands Between 0.15 MHz and 80 MHz 80 % AM at 1 kHz
Rated power frequency magnetic fields	IEC 61000-4-8	30 A/m 50 Hz or 60 Hz	30 A/m 50 Hz or 60 Hz
Voltage dips	IEC 61000-4-11	0 % UT; 0,5 cycle  A 0°, 45°, 90°, 135°, 180°, 225°, 270° and 315°  0 % UT; 1 cycle and 70 % UT; 25/30 cycle Single phase: at 0°	0 % UT; 0,5 cycle  A 0°, 45°, 90°, 135°, 180°, 225°, 270° and 315°  0 % UT; 1 cycle and 70 % UT; 25/30 cycle Single phase: at 0°
Voltage interruptions	IEC 61000-4-11	0 % UT; 250/300 cycle	The device will shut down and / or reset if power is interrupted for five seconds.

## Owner's Manual

Enclosure interface immunity to nearby magnetic fields	IEC 61000-4-39	65 <sup>b</sup> A/m 134,2 kHz Pulse modulation <sup>a</sup> 2,1 kHz  7,5 <sup>b</sup> A/m 13,56 kHz Pulse modulation <sup>a</sup> 50 kHz	65 <sup>b</sup> A/m 134,2 kHz Pulse modulation <sup>a</sup> 2,1 kHz  7,5 <sup>b</sup> A/m 13,56 kHz Pulse modulation <sup>a</sup> 50 kHz
--	----------------	--	--

NOTE 1 At 80 MHz and 800 MHz, the higher frequency range is applicable.

NOTE 2 These guidelines may not apply to all situations. Electromagnetic propagation is affected by the absorption and reflection of structures, objects and people.

<sup>a</sup> Modulated carrier uses a 50% duty cycle square wave signal.

<sup>b</sup> r.m.s., before applying the modulation.

### PROXIMITY FIELDS FROM WIRELESS RF COMMUNICATIONS EQUIPMENT

TEST FREQUENCY (MHZ)	BAND (MHZ)	SERVICE	MODULATION	MAXIMUM POWER (W)	DISTANCE (M)	IMMUNITY TEST LEVEL (V/M)
385	380-390	TETRA 400	Pulse modulation 18Hz	1.8	0.3	27
450	430-470	GMRS 460,FRS 460	FM ± 5 kHz deviation 1kHz sine	2	0.3	28
710	704-787	LTE 13, 17 Band	Pulse modulation 217 Hz	0.2	0.3	9
745						
780						
810	800-960	GSM 800/900, TETRA 800, iDEN 820, CDMA 850, LTE 5 Band	Pulse modulation 18 Hz	2	0.3	28
870						
930						
1720	1700 -1990	GSM 1800; CDMA 1900; GSM 1900; DECT; LTE 1, 3, 4, 25 Band, UMTS	Pulse modulation 217 Hz	2	0.3	28
1845						
1970						
2450	2400-2570	Bluetooth, WLAN 802.11 b/g/n, RFID 2450, LTE 7 Band	Pulse modulation 217 Hz	2	0.3	28
5240	5100 - 5800	WLAN 802.11 a/n	Pulse modulation 217 Hz	0.2	0.3	9
5500						
5785						





LIST OF CABLE USED		
CABLE	DESCRIPTION	LENGTH
Network	Flexible data cable, S/FTP, Category 5e or 6, AWG26	15 m
Remote exposure button	Data cable, U/UTP, Category 5, AWG24	15 m
Local exposure button	PVC spiral cable, flat section, 6 conductors, 100V, 70°C polypropylene insulation	5 m
Power Supply	Type SJT, 16 AWG, 1.31 mm <sup>2</sup> , STJ 3/C, 250 V, 60 °C, max 4.5 m long; One end with NEMA 5-15. Other end (with appliance coupler) (connected to unit)	3 m

	The Dental CT Scanner AXR is designed to obtain radiological images of the oral anatomy, including teeth, maxillofacial areas, oral structures, carpal images and head-neck bone regions, and it is for exclusive dental use only. In case of EM disturbances, the operator may experience loss of communication between the equipment and the computer.
---	--

	Compliance with EMC and EMI standards cannot be assured by the use of altered cables or that are not in conformity with the same standards under which the equipment has been validated.
---	--

	Use of this equipment adjacent to other equipment should be avoided because it could result in improper operation. If such use is necessary, this equipment and the other equipment should be observed to verify that they are operating normally.
---	--

	Don't use accessories, transducers, internal parts of components and other cables other than those previously specified by the manufacturer. This may result in increased emission or decreased electromagnetic immunity and result in improper operation.
---	--

	Portable RF communications equipment (including peripherals such as antenna cables and external antennas) should be used no closer than 30 cm to any part of the Dental CT Scanner AXR, including cables specified by the manufacturer. Otherwise, degradation of the performance of this equipment could result.
---	---

	To maintain basic safety in relation to electromagnetic disturbances during the expected service life, always use the equipment in the specified electromagnetic environment and follow the maintenance recommendations described in this manual
---	--



Pins, connector sockets or elements bearing the ESD warning symbol should not be touched or interconnected without ESD protection measures.

## PROTECTING YOUR IMAGING SYSTEM FROM CYBERSECURITY THREATS

## 14. PROTECTING YOUR IMAGING SYSTEM FROM CYBERSECURITY THREATS

Because the imaging computer may be connected by Wi-Fi or Ethernet to the Internet or via the hospital information system, cybersecurity may become an issue for you. Here are some tips to keep your system and your medical images secure. If your imaging system came with a Windows based computer system, it has had an anti-virus program installed on it. We request that you keep the operating system up to date with the operating system and anti-virus updates. You can view the status by typing Windows Update in the search box:

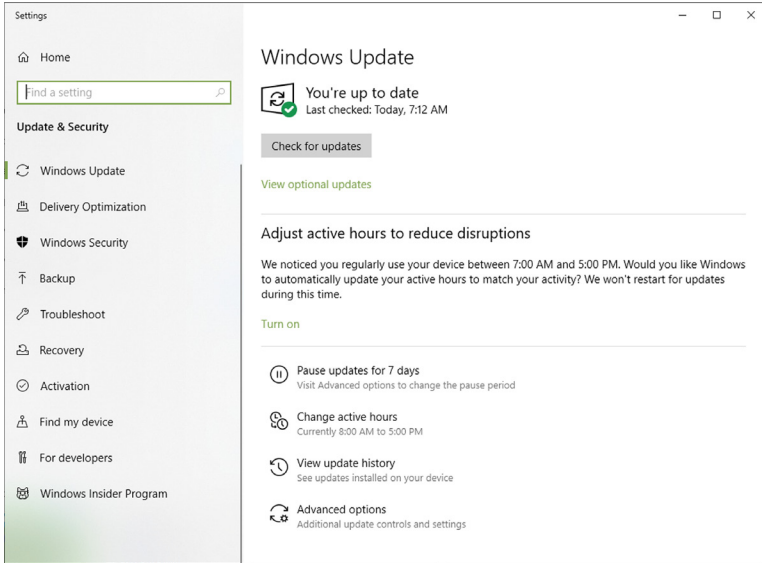

Also you can check the status of the anti-virus program by typing “Windows Security” in the search box:

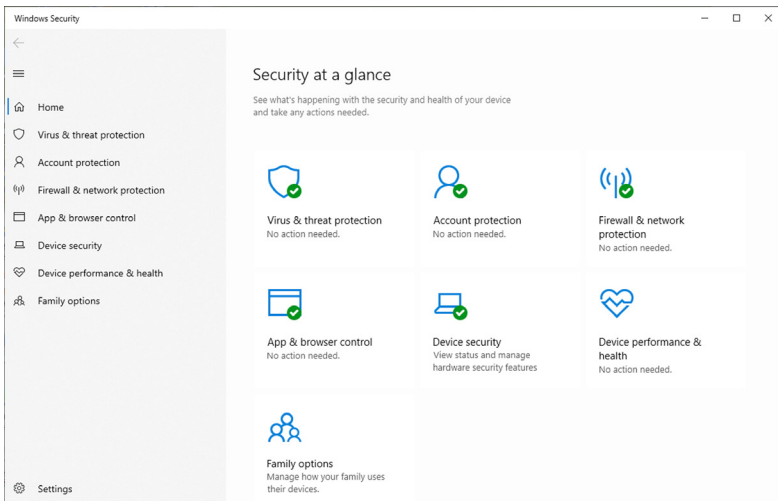

### Identify and Protect:

- Limit Access to Trusted Users Only: Limit access to devices through the authentication of users (e.g. user ID and password.)

### Ensure Trusted Content:

- Restrict software or firmware updates to authenticated code. USE ONLY MATERIALS SUPPLIED BY US FOR YOUR IMAGE MANAGEMENT SOFTWARE UPDATES.
- Use systematic procedures for authorized users to download version-identifiable software and firmware from the manufacturer.

### Detect, Respond, Recover:

- Watch for on-screen warnings of possible virus infections
- Respond by scanning for and removing possible virus infections
- Recover from possible virus infections by having up to date BACKUPS of your host computer.

### Required strategies:

It is required to install and operate the Dental CT Scanner AXR within a secure operating environment that allows access only to authorized users and the system network is equipped with Windows firewall built into the Windows system, Windows Defender antispymware tools and other security tools. third-party and commonly used application systems.

- Latest antivirus and firewall software updates are recommended.

- The software can only be updated by the manufacturer. Unauthorized software update by a third party, not the manufacturer, is strictly prohibited. For cybersecurity issues related to software and medical devices, please contact the manufacturer.

### A summary of our integrity controls

- Our development computers are constantly scanned for malware by our antivirus software vendor who has policies to update the software automatically as new threats are revealed. Antivirus Software constantly monitors your computer for possible new threats. Software vendor automatically updates its product as it discovers new threats on the web and makes software improvements.
- We perform daily backups to our external hard drives. These drives are then disconnected from the system after the backups.
- During software development we disconnect from the Internet to prevent external attacks.
- Our development process utilizes the Microsoft Malware Defense Guide.
- Copies of software updates we will be sending you are individually scanned for malware. USE ONLY MATERIALS SUPPLIED BY US FOR YOUR UPDATES.

### Target groups

- Operator;
- Integrator;
- User.

The groups described above should carefully read the specific cybersecurity-related technical information described in this manual.



This chapter clearly contains the technical descriptions of the target groups that illustrate how to operate this product in a technically safe way.

Below is a list of cybersecurity materials related to the concept of cybersecurity:

**Integrators:**

**Use antivirus programs such as:**

- Microsoft Defender
- TotalAV
- ScanGuard Security Suite
- Norton da Symantec
- PCProtect
- McAfee Antivirus Plus

Keep these products up to date.

**Users and Operator:**

Log in to the software only using their respective access keys (Hardkey).

Minimum platform requirements of the computers that will be connected to the product:

- See item 3.7.2 (Hardware Requirements) of this manual.



In case the computer's operating system is based on Windows, it has had an antivirus program installed on it. We ask that you keep your operating system up to date with operating system and antivirus updates.

**14.1.DESCRPTION OF SECURITY FEATURES AND FUNCTIONS**

Below is described the security features and functions of this product to protect the essential function even when the cyber security of the medical device or medical network is compromised.

FEATURE DESCRIPTION	SECURITY LEVEL OF CAPACITY (SL-C)	RISKS/THREATS COVERED BY THIS CAPABILITY SECURITY LEVEL
Identification and Control of authentication	SL-C 3 – Means this product has sophisticated capabilities that require advanced security knowledge, advanced domain knowledge, or any combination.	Protected against hashtable-based password or key cracking tools.
Usage control	SL-C 3 – Means this product has sophisticated capabilities that require advanced security knowledge, advanced domain knowledge, or any combination.	Protected against hashtable-based password or key cracking tools.
System integrity	SL-C 3 – Means this product has sophisticated capabilities that require advanced security knowledge, advanced domain knowledge, or any combination.	Protected against hashtable-based password or key cracking tools.
Data confidentiality	SL-C 4 – Means the attacker has sophisticated means, advanced security knowledge, and extended capabilities at their disposal.	Protected against super computers for brute-force password cracking.
Restrição do fluxo de dados	SL-C 4 – Means the attacker has sophisticated means, advanced security knowledge, and extended capabilities at their disposal.	Protected against super computers for brute-force password cracking.
Response to timely events	SL-C 1 – This level does not require much knowledge of the system.	Protected against unauthorized access during events or emergency access.
Resource availability	SL-C 1 – This level does not require much knowledge of the system.	Protected against unauthorized access during product updates.



Capacity security levels set for this product cannot be changed.

## 14.2. THREATS THAT MUST BE CONSIDERED BY THE MEDICAL NETWORK INTEGRATOR

- Vulnerability in assets in relation to security;
- Vulnerability in assets in relation to information security;
- Vulnerability in the intended use environment;
- Vulnerability in attack surface size;
- Public health impact taking into account the affected devices;

Below is a list of services that cannot be secured with the capability security level alone:

- Consequence of loss of basic security and essential performance;
- Indirect access to other assets;
- Physical environment;
- Number and accessibility of ports;
- Number of devices affected;



If anomaly conditions (ie cybersecurity events) are detected, the product acquisition software will immediately display a message to the user, requesting an evaluation of the same and making available to the user only the essential functions of the software.

## 14.3. INSTRUCTIONS FOR TARGET GROUPS ON HOW TO RESPOND AFTER THE DETECTION OF A VULNERABILITY

- Integrator: Respond by checking and removing possible virus infections.
- Operator and User: Pay attention to on-screen warnings of possible virus infections and perform backup.

If the product suffers an attack, the essential function mode is executed, providing only the functions below:



- Emergency button;
- Trigger interruption;
- Visualization of warnings and warnings;
- Access to the user manual;
- Configuration of image acquisition parameters;
- Triggering the equipment with manual triggering of the trigger (Remote or External);
- Changing settings between Panoramic, Tomography and Cephalometry;
- Registration of new patients;
- Generation of images, without the option of generating reports and editing;
- Performing a calibration check through the QA evaluation mode (Performance mode available in the User's Manual).

The product backup must be performed by the user/operator, where the same periodically or during an attack threat must save your database on an external hard drive or separate from your operating system.



# Owner's Manual

The software used in this product may only be installed and updated by an authorized Alliage technician.

	<p>It does not accept any software installation of this product by other unauthorized persons.</p>
	<p>This product cannot be remotely serviced while the equipment is in use.</p>
	<p>After product life or disposal, Alliage will no longer provide cybersecurity support for this product. Therefore, security updates cannot be performed.</p>

## 14.4.DETAILED SYSTEM DIAGRAM FOR TARGET GROUPS

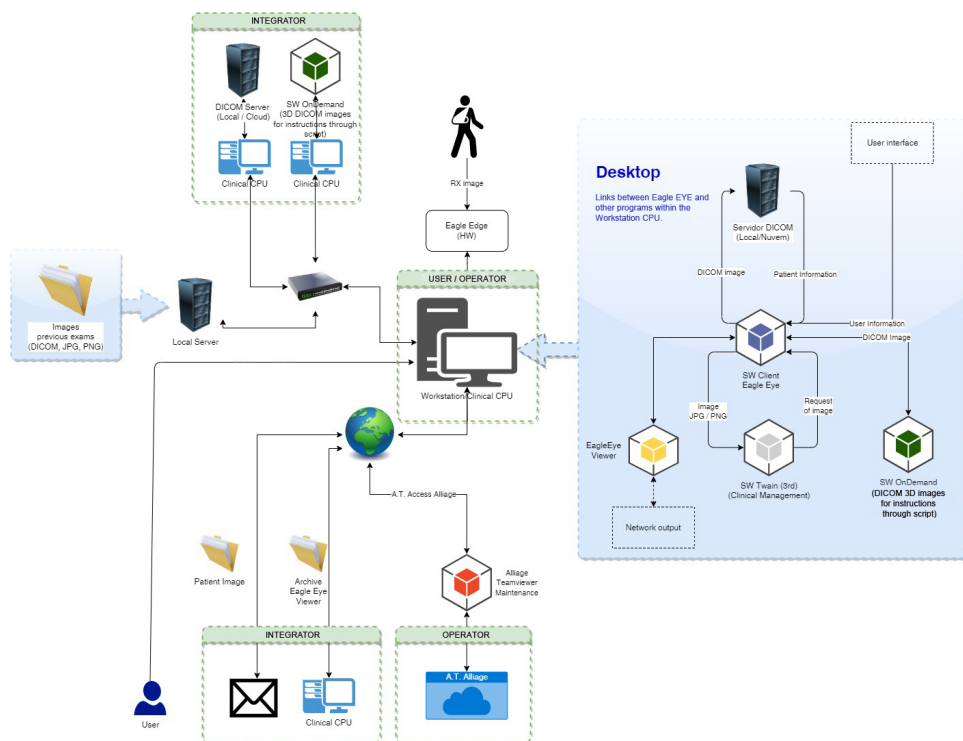

## 14.5.INTERFACES AND ACCESS POINTS

INTERFACE/ACCESS POINT	FUNCTIONS	TYPE OF NETWORK COMPONENTS THAT CAN BE CONNECTED	TYPE OF DATA/SIGNALS TO BE TRANSMITTED	PROTOCOL TYPES
On board microcomputer network port	Connection to the local network.	CAT6 or CAT5 cable.	Digital signals	TCP/IP protocol
Network port microcomputer network card	Connection to the Dental CT Scanner AXR	CAT6 cable with shield.	Digital signals	TCP/IP protocol
USB port	File transference	PEN DRIVE	Files	-
micro SD port	File transference	Micro SD	Files	-

### Conclusion

It is our JOINT responsibility to ensure your medical image software and image collection is safe and secure. We must both do our parts.



**DABI ATLANTE**