

English

**OWNER'S  
MANUAL**  
PERSUS L  
DENTAL LIGHT

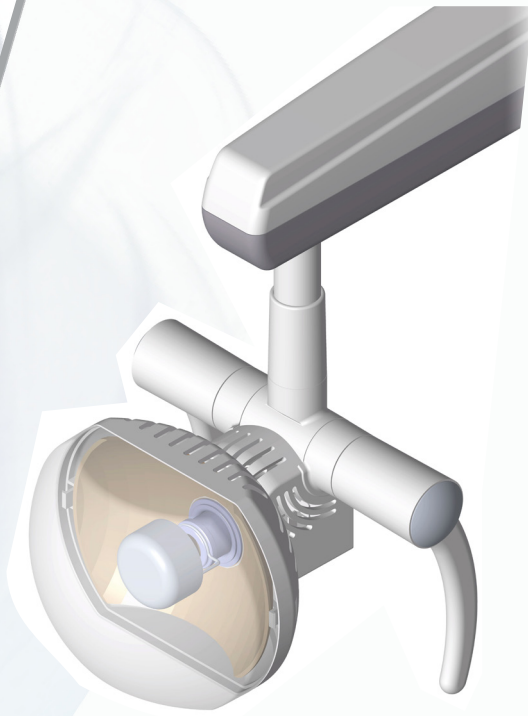

**DABI ATLANTE**

**PAGE INTENTIONALLY LEFT BLANK**

## MANUAL PRESENTATION

**Technical Name:** Dental Lights

**Commercial Name:** Dental Light

**Models:**

Persus L

Persus Piso

**Brand:** Dabi Atlante

**Technical Responsible:** Daniel R. de Camargo

CREA-SP: 5062199650

**ANVISA Registration No.:** 10069210069



Alliage S/A Industrias Médico Odontológica  
Rodovia Abrão Assed, Km 53 + 450m - CEP 14097-500  
Ribeirão Preto - SP - Brazil  
Phone: +55 (16) 3512-1212



CINTERQUAL – Soluções de Comércio  
Internacional, Lda.  
Avenida Defensores de Chaves, Nº 4  
Escritório Idea Spaces  
1000-117 Lisboa, Portugal



77000000967 - Rev.: 05 - March/22

Document originally written in Portuguese.

### **TRADEMARKS**

All terms mentioned in this manual that are known trademarks, registered trademarks or service marks have been appropriately labeled as such. Further products, services or terms that are mentioned in this manual may be registered marks, registered trademarks or service marks of their respective owners. Alliage S/A makes no claims regarding these trademarks. The use of a term in this manual should not be considered to influence the validity of any registered mark, registered trademark or service mark.

Copyright © 2019 Alliage S/A. All rights reserved.

The performance characteristics provided in this manual are for reference only and should not be considered as guaranteed specifications.

## TABLE OF CONTENTS

<b>1. GENERAL INFORMATION</b> .....	<b>8</b>
1.1. DEAR COSTUMER .....	8
1.2. INDICATIONS FOR USE .....	8
1.3. CONTRAINDICATION .....	8
1.4. SYMBOLOGY .....	8
<b>2. WARNINGS, PRECAUTIONS AND RECOMMENDATIONS</b> .....	<b>11</b>
<b>3. SYSTEM GENERAL DESCRIPTION</b> .....	<b>16</b>
3.1. SYSTEM DESCRIPTION .....	16
3.2. APPLICATION SPECIFICATION .....	16
3.2.1. Operation Principles .....	16
3.2.2. Significant physical characteristics .....	16
3.2.3. User's profile .....	16
3.3. MAIN PRODUCT COMPONENTS .....	17
3.3.1. Light .....	17
3.3.2. Arm .....	18
3.4. APPLIED PARTS .....	19
3.5. LABEL POSITIONING .....	19
3.6. SYSTEM REQUIREMENTS .....	19
3.6.1. Place of Installation .....	19
<b>4. OPERATION</b> .....	<b>21</b>
4.1. INITIAL PREPARATION .....	21
4.2. ACTIVATING THE LIGHT .....	21
4.3. MOVEMENT OF THE HEADSTOCK .....	23
<b>5. CLEANING AND DISINFECTION</b> .....	<b>25</b>
<b>6. PROBLEMS DIAGNOSTIC</b> .....	<b>27</b>
6.1. PROBLEMS SOLUTION .....	27
<b>7. INSPECTION AND MAINTENANCE</b> .....	<b>29</b>
7.1. PERIODIC INSPECTION .....	29
7.2. PREVENTIVE MAINTENANCE .....	29
7.3. CORRECTIVE MAINTENANCE .....	30
7.4. ALLIAGE AUTHORIZED SERVICE NETWORK .....	31
<b>8. WARRANTY</b> .....	<b>33</b>
<b>9. RULES AND REGULATIONS</b> .....	<b>35</b>
<b>10. TECHNICAL SPECIFICATIONS</b> .....	<b>37</b>
10.1. EQUIPMENT CLASSIFICATION .....	37
10.2. DEVICE INFORMATION .....	37
10.3. ENVIRONMENTAL CONDITIONS .....	38
10.4. LIGHT BEAM PROJECTION .....	38
10.5. DENTAL LIGHT DIMENSIONS .....	39

11. ELECTROMAGNETIC COMPATIBILITY..... 44  
11.1. GUIDANCE AND DECLARATION FOR ELECTROMAGNETIC EMISSIONS ..... 44  
11.2. GUIDELINES AND DECLARATION FOR ELECTROMAGNETIC IMMUNITY ..... 45

## GERENAL INFORMATION

## 1. GENERAL INFORMATION

### 1.1. DEAR COSTUMER

Congratulations on your excellent choice. When you buy ALLIAGE-quality equipment, you can be sure of purchasing products with technology compatible with the best in the world in their class. This manual offers you a general presentation of your equipment, describing important details that can guide you in its correct use, as well as in solving minor problems that may eventually occur. This manual must be read in full and kept for future reference.

### 1.2. INDICATONS FOR USE

The Dental Light is intended to assist in the treatment of the patient and in the performance of dental practices, and is for dental use only.

### 1.3. CONTRAINDICATION

There are no known contraindications for this equipment.

### 1.4. SYMBOLOGY

The following symbols are used both throughout this manual and on the product. Make sure you fully understand each symbol and follow the instructions that come with it.



Fragile, handle carefully



Maximum stacking



Protect from rain

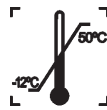

Temperature limit



This side Up



Protect from sunlight



Recyclable



Indicates that the product must be taken to a special waste collection site at the end of its shelf-life. Applies to both device and accessories





Electrostatic sensitive (ESD) devices



Protection ground



Refer to the instructions manual



Mandatory action



Caution



Overall warning



Authorized representative in European Union



Indicates that the equipment complies with Directives 2011/65/EU and 2015/863/EU on the Restriction on the use of certain hazardous substances in electrical and electronic equipment.



Model



Catalog number



Model number



Serial number



Manufacturer







Manufacturing date

## **WARNINGS, PRECAUTIONS AND RECOMMENDATIONS**

## 2. WARNINGS, PRECAUTIONS AND RECOMMENDATIONS

### Overall warnings



	Read and understand all instructions contained in these instructions for use before installing or operating this equipment.
	Use the equipment only in perfect condition and protect yourself, patients and others against possible hazards.
	This equipment must be installed and operated by personnel familiar with the necessary precautions.
	The Dental Light has 2 different interactions with the user, namely: - Identification label: Located on the side of the equipment; - Safety symbols: Located in risk areas and on its identification tag;

### During transportation

The equipment must be transported and stored, observing the following:

- Handle carefully to avoid falls, excessive vibrations and impacts;
- The arrows on the packaging must be pointing upwards;
- To handle the package as a single unit, consider the center of gravity indicator;
- Do not stack above the quantity indicated on the packaging;
- Do not walk or stand above the packaging
- Protect against sunlight, humidity, water and dust;
- Observe the temperature, pressure and relative humidity limits.

### During the installation of the equipment

	Installation instructions can be found in the service manual, accessible only to authorized technicians.
	The equipment must be installed only by the authorized technician. This technical procedure cannot be performed by the user.

- The equipment must be installed only by authorized technicians.
- The service manual's recommendations regarding the mandatory existence of protective grounding must be followed.
- Install the equipment in a location where it will not be in contact with humidity, water, plants and animals.
- Install the equipment in a location where it will not be damaged by pressure, temperature, humidity, direct sunlight, dust, salts or corrosive products.
- This equipment is not designed for use in the presence of steams from flammable anesthetic mixtures or nitrous oxide.
- Place any other external devices at least 1.5 meters away from the equipment, so that the patient cannot touch any other external devices while they are being attended to.
- The recommendations in this manual for EMC should be followed. Communication equipment and RF generating sources can affect the operation of the equipment.
- Equipment can cause radio interference or interrupt the operation of nearby equipment, making it necessary to take mitigating measures, such as reorientation, relocation of the equipment or shielding of the location.

### Before using the equipment

In order to help ensure proper hygiene and protect against infectious diseases, before the first use, the equipment must be cleaned and disinfected according to the instructions contained in this manual.

### While using the equipment

- Under no circumstances can the patient operate the equipment.
- The patient must not touch any parts other than those specific for their treatment.
- The equipment must be operated only by qualified health professionals.
- To operate the equipment, operating personnel must:
  - Read and understand the user manual
  - Be familiar with the basic structure and functions of this equipment.
  - Be familiar with the emergency situation protocols for this equipment.
  - Be able to recognize irregularities in the operation of the equipment and implement the appropriate measures, when necessary.
- This equipment was designed according to the electromagnetic compatibility standards, but in very extreme conditions, it can cause interference with other equipment. Do not use this equipment in conjunction with other devices that are very sensitive to interference or with devices that create high electromagnetic disturbances.
- If this product is exposed to water, humidity or foreign substances, turn it off immediately and contact an Alliage Authorized Service Center.
- In case of damage or defect, do not use the equipment and contact an Alliage Authorized Service Center.
- Do not use the equipment if any of its compartments or parts are damaged, loose or have been removed. Contact an Alliage Authorized Service Center and request repair or replacement of any damaged, loose or removed cabinets or parts of the equipment before using it again.
- Do not touch the equipment or use it if it is being repaired or if the equipment's cabinets have been removed.
- Do not open or remove any of the equipment's cabinets. No internal parts can be repaired by the user.
- In case of falling or impact of moving parts causing their breakage, be careful when handling

them, there may be sharp parts.

- This equipment does not produce physiological effects that are not obvious to the operator.
- The operator cannot come into contact with the patient when in contact with accessible connectors.
- The operator cannot use tools to open the equipment.

### Cross-contamination prevention



Adequate cleaning and disinfection measures should be taken to avoid cross-contamination between patients, users and others.

- For each new patient, perform cleaning and disinfection procedures according to the instructions contained in this manual.

### After using/ operating the equipment

- Turn off the equipment if it is not in use for a long time
- All parts that have been in contact with the patient should be cleaned and disinfected for each new patient, in order to prevent the transmission of infectious agents that can cause serious illness.
- Perform cleaning and disinfection according to the instructions contained in this manual.
- Do not unplug the cable or other connections unnecessarily.
- Do not modify any part of the equipment.

### Precautions in case of altered equipment operation

If the equipment shows any abnormality, check if the problem is included in any item listed in the "Problem diagnosis" topic of this user manual.

If it is not possible to solve the problem, turn off the equipment and contact an Alliage Authorized Service Center.



The manufacturer is NOT responsible for:

- The equipment being used for purposes other than those for which it was designed.
- Damage caused to the equipment, the operator and/or patient, as a result of incorrect installation and maintenance procedures that are not in accordance with the operating instructions accompanying the equipment.
- Inadequate equipment operation.

### Precautions for reducing environmental impact

Alliage S/A aims to achieve an environmental policy to promote the supply of environmentally conscious medical and dental products that continually minimize environmental impact and are friendlier to the environment and human health. In order to maintain a minimal environmental impact, observe the recommendations below:

- After installation, send recyclable materials for recycling process.
- During the life cycle of the equipment, turn it off when it is not in use.
- To prevent environmental contamination, the disposal of waste and consumables must follow the usual procedure for biomedical waste.

Biomedical waste encompasses non-acute materials that may cause disease or suspicion of harboring pathogenic organisms that must be stored in a yellow bag properly labeled with a biohazard symbol, stored in a puncture-resistant, watertight container until collection and incineration.



The Equipment's packaging consists of wood, cardboard, plastic and expanded polyurethane (PU) which are 100% recyclable materials.

SIZES:

Main unit: 420 x 420 x 220mm/ MASS: Approximately: 2 Kg

Arm: 910 x 720 x 140mm/ MASS: Approximately: 10 Kg

### Precautions in case of unusable equipment

In order to avoid environmental contamination or improper use of the equipment, when it is unusable, it must be disposed of (in accordance with current legislation) in an appropriate place, as the materials inside can contaminate the environment.

For the European Economic Area (EEA), this product is subject to Directive 2012/19/EU, as well as the corresponding national laws. This directive requires that the product must be taken to a special waste collection site at the end of its shelf-life. Applies to both the device and accessories. Contact your salesperson if final product disposal is required.



This equipment must not be disposed of as household waste.

## SYSTEM GENERAL DESCRIPTION

## **3. SYSTEM GENERAL DESCRIPTION**

### **3.1. SYSTEM DESCRIPTION**

Focal dental reflector with a luminosity of 25,000 Lux.

Head made of resistant material with a rotation of 620°.

Hinged arm with horizontal and vertical movements with a stroke limit jamb, sustained by a set of springs that allow a smoother and accurate movement.

Handle-shaped bilateral knobs, with an appropriate design for placing sterilized protectors avoiding the risk of cross contamination.

Multi-sided glass mirror with multi-coating treatment generates several white and cold light sources. Do not provoke shadows caused by the surgeon dentist's hands or head interposition.

Optical mirror protector in sturdy and transparent material protecting the mirror completely. Triggering through the chair's \*control paddle, optimizing biosafety or through a \*switch shaft embedded to the reflector's head (depending on the coupling).

Flat high gloss epoxy painting polymerized in an oven at 250°C; with corrosion and cleaning material resistant phosphate treatment.. dull white as the standard color, compatible with all surroundings.

### **3.2. APPLICATION SPECIFICATION**

#### **3.2.1. Operation Principles**

Conventional illumination of incandescent halogen light with tungsten filament contained in an inert gas with a small amount of a halogen element such as iodine or bromine.

#### **3.2.2. Significant physical characteristics**

Monofocal reflector for dental use with a luminosity of 25,000 Lux and multifaceted mirror with Multicoating treatment that generates numerous sources of white and cold light.

#### **3.2.3. User's profile**

The Dental Light can be used by both male and female, with the minimum level of literacy, and with the ability to read and understand images, symbols, icons, western characters (Arial font), and alphanumeric characters. People who use the Dental Light may not have a degree of visual imperfection for reading or seeing and an average degree of recent memory impairment, not being clearly able to perform the activities and functions of the product correctly in the profession.

The user needs to be a healthcare professional that has been qualified and trained to perform the activities, functions frequently used in the application of the Dental Light and its primary operations functions.



### 3.3. MAIN PRODUCT COMPONENTS

#### 3.3.1. Light

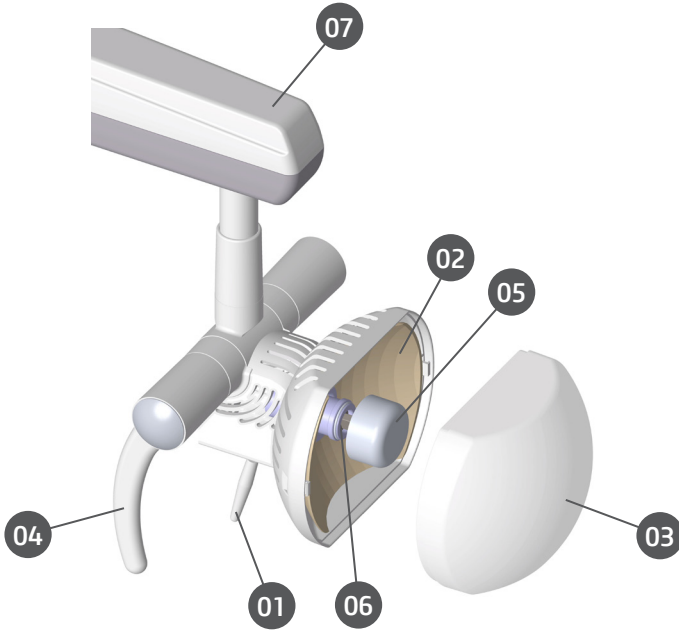

- \* 01 - Switch Shaft On/Off
- 02 - Multi-sided glass mirror
- 03 - Protective cover
- 04 - Handles
- 05 - Protective lamp
- 06 - Lamp
- 07 - Hinged arm

---

\* Optional items (Subject to commercial availability)

### 3.3.2 Arm



\*Supports for coupling in the chair (allows the installation of the articulated arm)

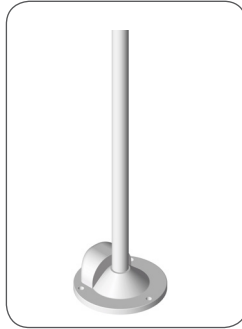

\*Support for floor/ ceiling coupling (allows the installation of the articulated arm)



\*Articulated arm



\*Simple bench articulated arm

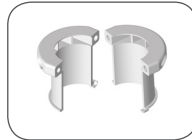

\*Sleeve Kit - allows the fixation of the Light in offices with 38mm column



\*double bench articulated arm



\*Articulated arm with "orbital" movement

\*Optional items (Subject to commercial availability)

### 3.4. APPLIED PARTS

This equipment does not have applied parts

### 3.5. LABEL POSITIONING

The following figure illustrates the location of the labels on the equipment.

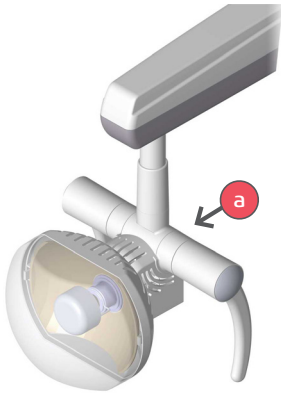

Illustrative picture

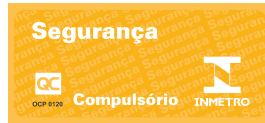
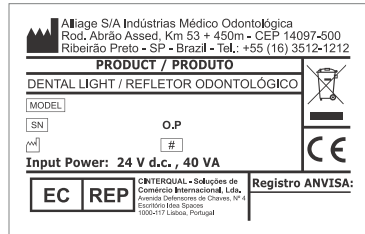

### 3.6 SYSTEM REQUIREMENTS

#### 3.6.1. Place of Installation



In order to meet safety standards, do not operate non-medical equipment, such as personal computers, within the patient's area. Outside the patient's area, the presence of non-medical equipment is acceptable, provided that approved and certified computer equipment is used.

Computer equipment must be CE-approved and must comply with CE 60950-1: 2005 + AMD1: 2009 + AMD2: 2013 and low voltage 2014/35/EU and 2014/30/EU EMC guidelines.

# 4

## OPERATION

## 4. OPERATION

### 4.1 INITIAL PREPARATION



The equipment must be cleaned and disinfected before use on a new patient, observing the instructions contained in this manual.

### 4.2. ACTIVATING THE LIGHT

#### How to start the reflector

\*Features a luminosity control with progressive adjustment or single intensity (on/off).

#### Coupled to the floor and stand

Just turn the on/off switch to start the reflector (01).

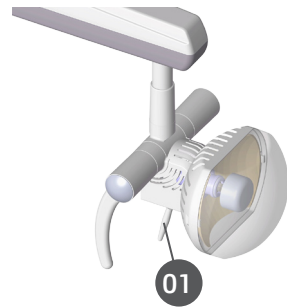

#### Coupled to the chair with a "3 keys" paddle

To start the reflector, push button (02) through the dental chair's control paddle and keep pressing it to change luminosity; luminosity will gradually change.  
To turn it off, Press button (02) once more.

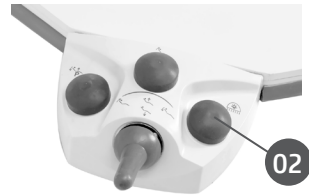

#### Coupled to the chair with a "Joystick" paddle (7 keys)

Press and release the key (02) to turn the dental light on or off. To switch the light intensity of the dental light, keep pressing the key until the reflector reaches the desired intensity.



\* Optional items (Subject to commercial availability)

### Coupled to the chair with a "7 keys" paddle

To start the reflector, push button (02) through the dental chair's control paddle and keep pressing it to change luminosity; luminosity will gradually change.  
To turn it off, Press button (02) once more.

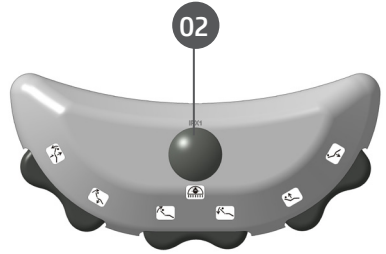

### Coupled to the chair with a "Joystick" paddle (5 keys)

To start the reflector, push button (03) through the dental chair's control paddle and keep pressing it to change luminosity; luminosity will gradually change.  
To turn it off, Press button (03) once more.



### Coupled to the chair with an "11 keys" paddle

To start the reflector at maximum luminosity, press button (05). To turn it off, press it again.  
To modify luminosity start the reflector pressing button (04) which will turn it at the higher defined luminosity, by keeping it pressed, the luminosity will increase or decrease.  
To turn it off, press the button (04) again.

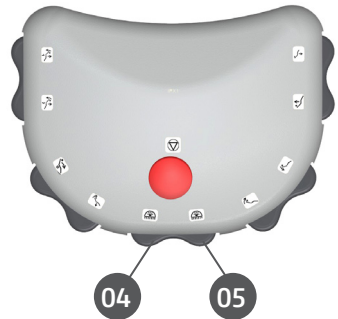

### Coupled to the chair with a "Chip Blower" paddle

Features a multifunctional key for activating the reflector.  
To start the Reflector at maximum luminosity, press the button (07). To turn it off, press it again.  
To modify the luminosity start the reflector pressing the button (06) which will turn it at the higher defined luminosity, by keeping it pressed; the luminosity will increase or decrease. To turn it off, press the button (06) again.

#### ATTENTION:

For the Equipments (without Bien Air panel) the pedal button (06) will have the rotation micro-electric motor reversing function.



### 4.3. MOVEMENT OF THE HEADSTOCK

The movement of the headstock is made through the knob (08), totally ergonomic designed to provide absolute isolation.



Position the headstock 70cm of the operative field.



When handling the equipment, take care with the parts that could pinch fingers.

# 5

## CLEANING, DISINFECTION AND STERILIZATION



## 5. CLEANING AND DISINFECTION



Before starting the cleaning and disinfection procedure, turn off the main switch of the equipment to avoid permanent damage.



For your protection, during the equipment cleaning and disinfection process, use PPE such as disposable gloves and goggles.

The cleaning and disinfection process must be performed at each patient change.

When starting the process, check for visible dirt, such as blood or saliva.

For cleaning, use a clean, soft cloth moistened with mild soap and then dry with a clean, soft cloth or paper towel.

For the disinfection process of the equipment, use disinfectant detergent foam that has active components based on didecyldimethylammonium chloride.

Apply the disinfectant detergent foam on the surface or on a clean cloth and spread it on the surface to be treated. Respect the antimicrobial contact time specified by the manufacturer. After application, allow to dry. Do not rinse.



Do not spill disinfectant liquid on the equipment.



Do not use organic solvents, for example, thinner, to clean the equipment. In the event that the development solution is spilled on the panel, clean it immediately, as these solutions may compromise the equipment's paint.

# 6

## PROBLEMS DIAGNOSTIC

## 6. PROBLEMS DIAGNOSTIC

### 6.1. PROBLEMS SOLUTION

In case any problem is found in the operation, follow the instructions below to check and fix the problem, and/or contact your representative.

Unforeseen events	Probable Cause	Solutions
- The light does not turn on;	- Lack of energy. - Burnt fuse. - Burnt Lamp.	- Wait for power to be restored. - Turn off the chair power and request the presence of a Technician. - Request the presence of a technician.

If problems persist, contact the Alliage Service Department.

# 7

## INSPECTION AND MAINTENANCE

## 7. INSPECTION AND MAINTENANCE



Maintenance or service procedures may only be carried out by a technical service authorized by the manufacturer.

All instructions for using the equipment as intended are provided in this user's guide. If a problem is detected and cannot be corrected with the instructions in the problem diagnostics section, contact the Alliage Service Department.

### 7.1. PERIODIC INSPECTION

This equipment must be regularly inspected to ensure operational safety and functional reliability. This inspection must be carried out by personnel familiar with the necessary precautions to avoid exposing the patient to risk.

Periodic inspection should be carried out at regular intervals (at least once a year) to ensure that the product is permanently safe and operational. All components subject to normal wear and tear should be checked and, if necessary, replaced.

The manufacturer and the assembler/ installer are exempt from responsibility for the standard results not being compliant in cases where the user does not perform the maintenance recommended by the manufacturer.

Neither inspection nor service is part of the equipment's warranty.

The maintenance performed must be documented and kept with the equipment.

Item	Inspection description	Recommended frequency
Security system	Collision, Warning Lights, and Interlock	Daily
Electric parts	Overheating/ Noise/ Burning smell	Monthly
Elevation	Operation/ Noise/ Vibration	Annually
Movement mechanism	Operation/ Noise/ Vibration	Annually
Pedal and controls	Operation/ Damage	Annually







If problems are detected during the inspection, contact the Alliage Service Department.

### 7.2. PREVENTIVE MAINTENANCE

In addition to the annual inspection, in order to ensure a long durability and the good operation of your equipment, it is important to carry out preventive maintenance for a maximum period of three (3) years.

Please contact the Alliage Service Department about our periodic review and preventive maintenance program.

### 7.3. CORRECTIVE MAINTENANCE

	To repair or replace any part, see instructions in the service manual.
	Corrective maintenance cannot be performed by the user. Do not open the equipment or try to repair it yourself or with the help of someone without training or authorization. This can aggravate the problem or produce a failure that can compromise the safety of the equipment.
	The power cables and electronic boards can be changed only by the authorized technician. See service manual for connection and anchoring information.
	No maintenance or services can be provided to the equipment or any of its parts during use with a patient.
	The equipment contains parts under high voltage. Risk of electric shock. Turn off the main switch before servicing.
	Moving parts can cut or crush.
	The service manual is only available for Authorized Technical Assistance.

Alliage declares that the provision of circuit diagrams, component lists or any other information that provides technical assistance on behalf of the user, can be requested as long as previously agreed between the user and Alliage. The warranty will be void if the original parts are removed/ replaced by unauthorized service technicians.

### 7.4. ALLIAGE AUTHORIZED SERVICE NETWORK

All services performed on the Alliage equipment must be performed by an Authorized Technical Assistant, as otherwise they will not be covered by the warranty. If you need to request electrical diagrams and or specification of components that is not stated in the user's manual, use the Alliage Customer Service to make the request.

Telephone: +55 (16) 3512-1212

Address: Rodovia Abrão Assed, Km 53 - Recreio Anhanguera – Ribeirão Preto-SP/ Brazil - Zip Code 14097-500.

# 8

## WARRANTY



## **8. WARRANTY**

This equipment is covered by the warranty periods, terms and conditions contained in the Warranty Certificate that comes with the product.

# 9

## **RULES AND REGULATIONS**

## 9. RULES AND REGULATIONS

This equipment has been designed and manufactured to meet the following standards:

ABNT NBR IEC 60601-1:2010 Amendment 1:2016	Medical Electrical Equipment - Part 1: General requirements for basic safety and essential performance.
ABNT NBR IEC 60601-1-2:2017	Medical Electrical Equipment, Part 1-2: General requirements for basic safety and essential performance - Collateral standard: Electromagnetic interference - Requirements and tests.
ABNT NBR IEC 80601-1-60:2015	General requirements for basic safety and essential performance of dental equipment
ABNT NBR 60601-1-6:2011	Electro-medical equipment - Part 1-6: General requirements for basic safety and essential performance - Collateral standard: Usability;
ABNT NBR IEC 62366:2016	Healthcare products - Application of usability engineering to healthcare products;
IEC 60601-1-9:2014	Medical electrical equipment - Part 1-9: General requirements for basic safety and essential performance - Collateral standard: Requirements for environmentally conscious design
IEC 62304:2006	Medical device software - Software lifecycle processes.
ISO 9680:2014	Operating lights
ISO 7494-1:2018	Dentistry – Dental units – Part 1: General requirements and test methods
ISO 7494-2:2015	Dental units – Part 2: Air, water, suction and wastewater Systems
ABNT NBR ISO 6875:2014	Dental patient chair
ISO 9687:2015	Graphical symbols for dental equipment
ISO 15223-1:2016	Graphic symbols for electrical equipment in medical practice
EN 1041:2008+A1 2013	Information provided by the medical device manufacturer.
ABNT NBR ISO 10993-1:2013	Biological assessment of medical devices - Part 1: Assessment and testing.
ABNT NBR ISO 14971:2009	Medical devices - Application of risk management to medical devices.
ABNT NBR ISO 13485:2016	Quality management systems - Requirements for regulatory purposes

# 10

## TECHNICAL SPECIFICATIONS

## 10. TECHNICAL SPECIFICATIONS

### 10.1. EQUIPMENT CLASSIFICATION

**Classification according to ANVISA**

Class I

**Classification according to CE/FDA**

Class I

**Equipment classification according to EN IEC 60601-1**

**Product classification for applied parts**

N/A

**Protection Against Electric Shock**

Class I

**Protection Against Harmful Water Penetration**

IP00 - Product not protected against harmful penetration of water and particulate material

**Degree of safety of application in the presence of a flammable anesthetic mixture with air, oxygen or nitrous oxide**

Unsuitable equipment

**Operation mode**

Continuous operation

### 10.2. DEVICE INFORMATION

**Power supply voltage (from the chair)**

24 Vcc

**Power consumption (from the chair)**

55VA

**Net weight of light head**

1 kg

**Gross weight of light head**

1,5 kg

### SPECIFIC INFORMATION

**Luminosity**

25.000 Lux

**Color temperature**

4500K to 6400K

**Color rendering index**

Ra > 85

### Lamp

H3 12V 55W

### Distance between the headstock and the operative field

70cm

## 10.3. ENVIRONMENTAL CONDITIONS

### Environmental conditions for transport and storage

#### Room temperature range for transport or storage

-12°C to +50°C

#### Relative humidity range for transport and storage

< 85% RH

#### Atmospheric pressure range

700 hPa to 1060 hPa  
(525 mmHg to 795 mmHg)

### Environmental conditions for installation and operation

#### Room temperature range for operation

+10°C to +35°C

#### Operating relative humidity range (non-condensing)

< 75% RH

#### Atmospheric pressure range

700 hPa to 1060 hPa  
(525 mmHg to 795 mmHg)

#### Operating altitude

≤ 2000 m

## 10.4. LIGHT BEAM PROJECTION

Projection	Perimeter (mm)	Area (mm <sup>2</sup> )
100%	437	13497
75%	361	9441
50%	286	6105
10%	169	2263

### 10.5 DENTAL LIGHT DIMENSIONS

#### Conventional Arm (Coupled to the chair)

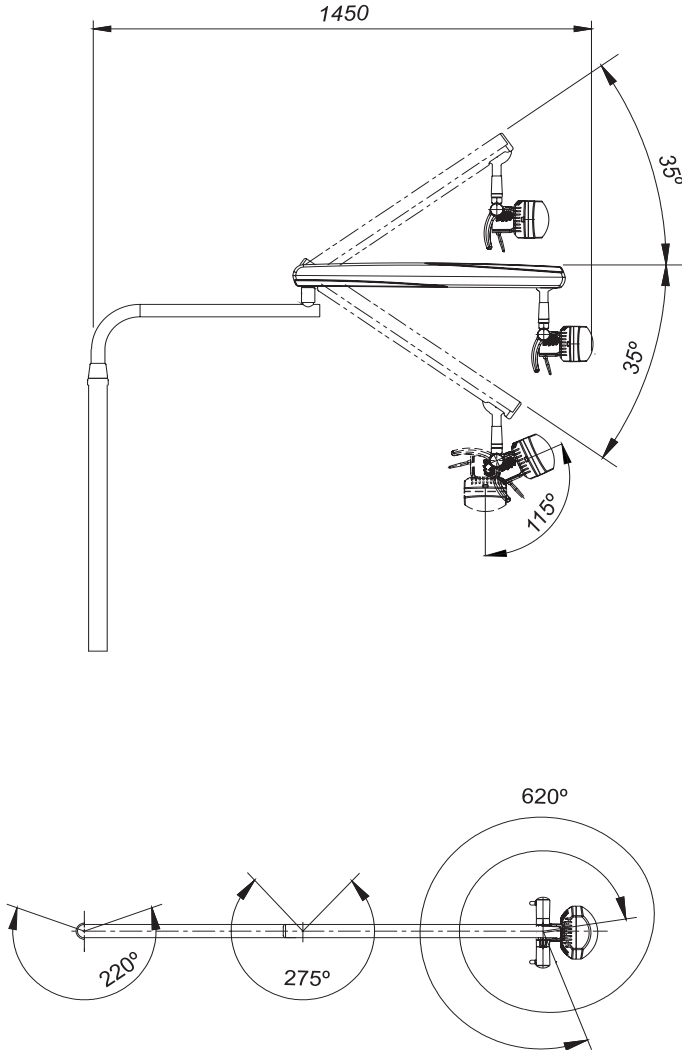

Floor

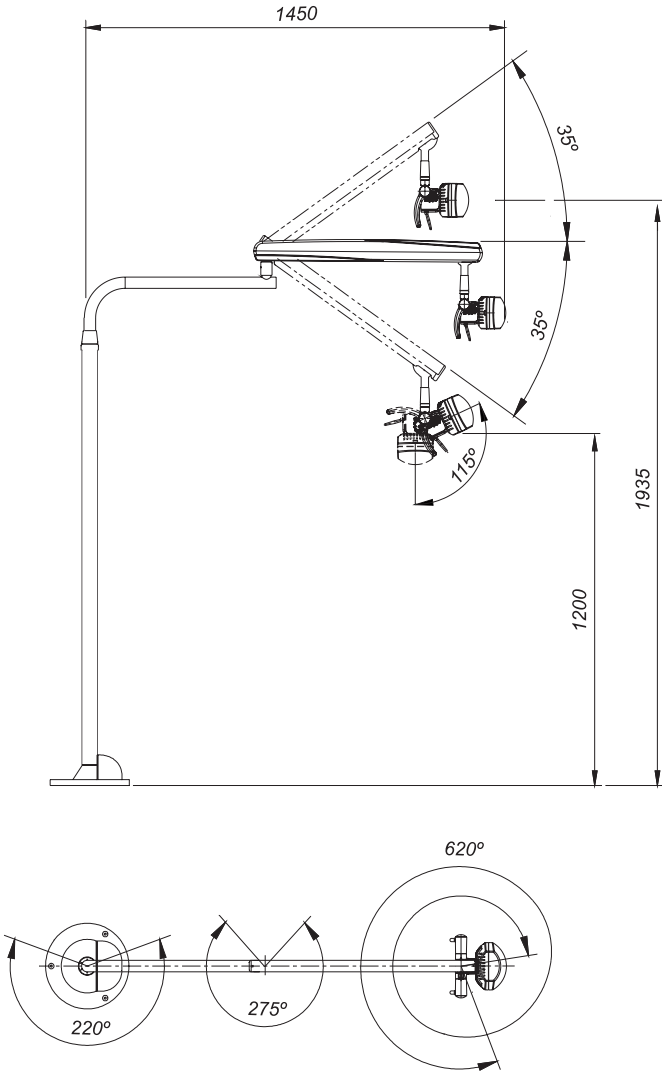



### Simple bench

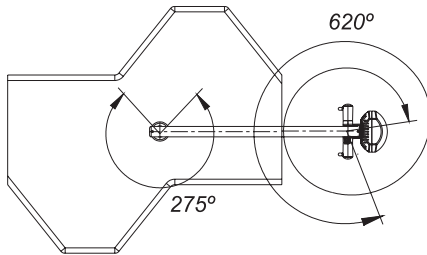
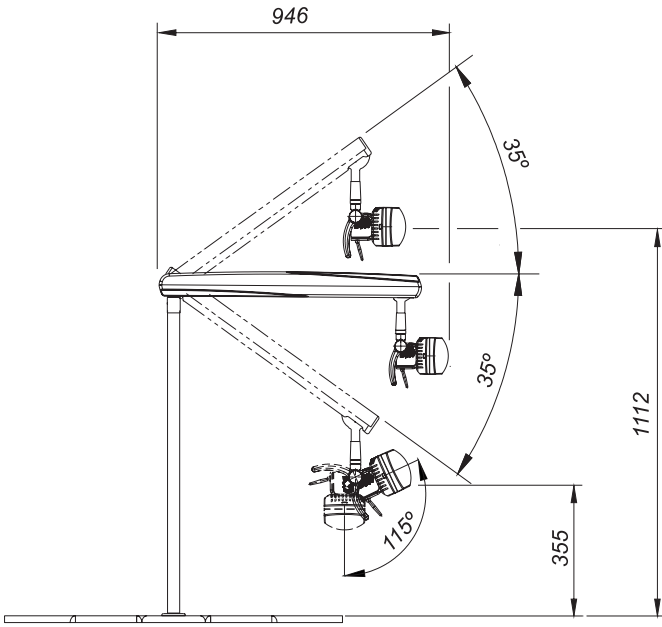

Double bench

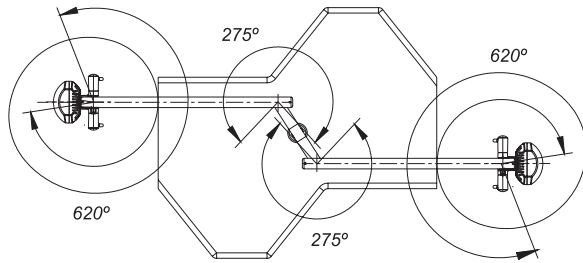
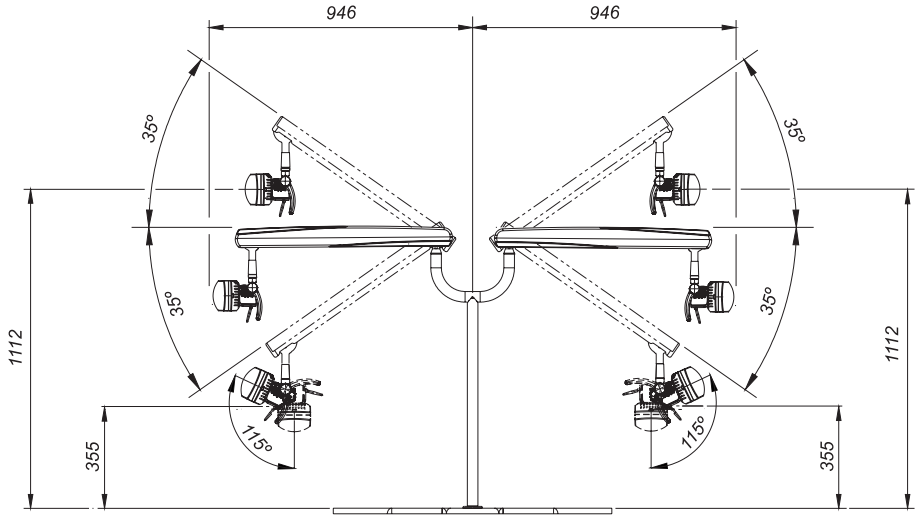

## ELECTROMAGNETIC COMPATIBILITY

## 11. ELECTROMAGNETIC COMPATIBILITY

The Dental Light is intended for use in the electromagnetic environment specified below. The buyer or user should ensure that it is used in such an environment.

The Dental Light is suitable for use in a professional healthcare environment, not including areas where there is sensitive equipment or sources of intense electromagnetic disturbances, such as the RF shielded room of a magnetic resonance imaging system, in operating rooms close to active AF surgical equipment, electrophysiology laboratories, armored rooms or areas where short wave therapy equipment is used.

The following tables provide information on the equipment's compliance with the ABNT NBR IEC 60601-1-2: 2017 standard.

### 11.1. GUIDANCE AND DECLARATION FOR ELECTROMAGNETIC EMISSIONS

Emission assay	Compliance	Electromagnetic Environments – guidelines
Emissions of RF CISPR 11	Group 1	The Dental Light uses RF energy only for its internal functions. Therefore, its RF emissions are very low and are unlikely to cause any interference in nearby electronic equipment.
Emissions of RF CISPR 11	Class A	The Dental Light is suitable for use in all facilities, except domestic ones and those directly connected to the public low voltage power supply network that supplies buildings used for domestic purposes.
Harmonic emissions IEC 61000-3-2	Class A	
Voltage fluctuation/ Scintillation emissions IEC 61000-3-3	Complies	

**Note:** The emission characteristics of this equipment make it suitable for use in industrial areas and hospitals (IEC/CISPR 11, Class A). If used in a residential environment (for which IEC/CISPR 11, Class B is normally required), this equipment may not provide adequate protection for radio frequency communication services. The user may need to take mitigation measures, such as relocating or redirecting equipment.

11.2. GUIDELINES AND DECLARATION FOR ELECTROMAGNETIC IMMUNITY

Phenomenon	Basic EMC standard or test method	Immunity assay level	Compliance level
Electrostatic discharge	IEC 61000-4-2	±8 KV contact ± 2 KV, ± 4 KV, ± 8 KV, ± 15 KV air	±8 KV contact ± 2 KV, ± 4 KV, ± 8 KV, ± 15 KV air
Radiated RF EM fields	IEC 61000-4-3	3 V/m 80 MHz – 2,7 GHz 80 % AM to 1 kHz	3 V/m 80 MHz – 2,7 GHz 80 % AM to 1 kHz
Fields close to RF wireless communication equipment	IEC 61000-4-3	Refer to table	Refer to table
Fast/ saved electrical transients	IEC 61000-4-4 power supply a.a.	± 2 kV 100 kHz repetition frequency	± 2 kV 100 kHz repetition frequency
	IEC 61000-4-4 signal input/ output	± 1 kV 100 kHz repetition frequency	± 1 kV 100 kHz repetition frequency
Outbreak line-line	IEC 61000-4-5	± 0,5 kV, ± 1 kV	± 0,5 kV, ± 1 kV
Outbreak line-earth	IEC 61000-4-5	± 0,5 kV, ± 1 kV, ± 2 kV	± 0,5 kV, ± 1 kV, ± 2 kV
Conducted disturbances induced by RF fields	IEC 61000-4-6	3 V 0.15 MHz – 80 MHz 6V in ISM bands between 0.15 MHz and 80 MHz 80 % AM to 1 kHz	3 V 0.15 MHz – 80 MHz 6V in ISM bands between 0.15 MHz and 80 MHz 80 % AM to 1 kHz
Magnetic fields at the stated supply frequency	IEC 61000-4-8	30 A/m 50 Hz or 60 Hz	30 A/m 50 Hz or 60 Hz
Voltage drops	IEC 61000-4-11	0 % UT; 0.5 cycle A 0°, 45°, 90°, 135°, 180°, 225°, 270° and 315° 0 % UT; 1 cycle and 70 % UT; 25/30 cycles Monophase: at 0°	0 % UT; 0.5 cycle A 0°, 45°, 90°, 135°, 180°, 225°, 270° and 315° 0 % UT; 1 cycle and 70 % UT; 25/30 cycles Monophase: at 0°
Voltage interruptions	IEC 61000-4-11	0 % UT; 250/300 cycles	The device will shut down or restart if the power is interrupted for five seconds.

NOTE 1 At 80 MHz and 800MHz, the higher frequency range is applicable.

NOTE 2 These guidelines may not apply in all situations. Electromagnetic propagation is affected by absorption and reflection from structures, objects and people.

NOTE 3 UT is the mains voltage c.a. before applying the test level.

## Fields close to RF wireless communication equipment

Testing frequency (MHz)	Band (MHz)	Service	Modulation	Maximum power(W)	Distance (m)	Immunity assay level (V/m)
385	380-390	TETRA 400	18 Hz pulse modulation	1.8	0.3	27
450	430-470	GMRS 460, FRS 460	FM deviation of $\pm$ 5 kHz Sinusoidal 1kHz	2	0.3	28
710 745 7480	704-787	LTE Band 13, 17	217 Hz pulse modulation	0.2	0.3	9
810 870 930	800-960	GSM 800 / 900 , TETRA 800, IDEN 820, CDMA 850, LTE 5 Band	18 Hz pulse modulation	2	0.3	28
1720 1845 1970	1700 -1990	GSM 1800; CDMA 1900; GSM 1900; DECT; LTE Band 1, 3, 4, 25; UMTS	217 Hz pulse modulation	2	0.3	28
2450	2400-2570	Bluetooth, W L A N 802.11	217 Hz pulse modulation	2	0.3	28
5240 5500 5785	5100 - 5800	b/g/n, RFID 2450, LTE 7 Band	217 Hz pulse modulation	0.2	0.3	9

List of cables used

Cables	Description	Length
Supply	Tripolar Power Cable Gauge 3x2.50 mm <sup>2</sup> , 250V AC, Male Plug 20A NBR 14136 2P+T, no female plug, Inmetro. (From the Chair).	3 m

	The Dental Light is intended to assist the healthcare professional, and it is for dental use only. In case of EMC disturbances, the operator may experience loss of communication between the equipment and controls.
---	---

	Compliance with EMC and EMI standards cannot be guaranteed by using cables that have been altered or that do not comply with the same standards for which the equipment has been validated.
---	---

	Use of this equipment adjacent to other equipment should be avoided, as it may result in improper operation. If this use is necessary, it is advisable that this and the other equipment be observed to verify that they are operating normally.
---	--

	Do not use accessories, transducers, internal parts of components and cables other than those previously specified by the manufacturer. This can result in increased emission or decreased electromagnetic immunity and result in improper operation.
---	---

	Portable RF communication equipment (including peripheral items, such as antenna cables and external antennas) should not be used within 30 cm away from any part of the equipment, including cables specified by the manufacturer. Otherwise, performance degradation of this equipment may occur.
--	---

	In order to maintain basic safety from electromagnetic disturbances during the expected shelf-life, always use the equipment in the specified electromagnetic environment and follow the maintenance recommendation described in this manual.
---	---

	The pins, connector sockets or elements that carry the ESD warning symbol must not be touched or connected without ESD protection measures.
---	---













CINTERQUAL - Soluções de  
Comércio Internacional, Lda.  
Avenida Defensores de Chaves, Nº 4  
Escritório Idea Spaces  
1000-117 Lisboa, Portugal

NUM. REG. ANVISA: 10069210069

**DABI ATLANTE**