

01

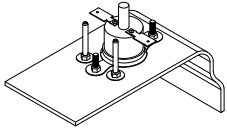

02

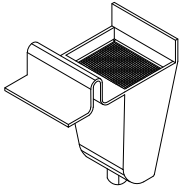

03

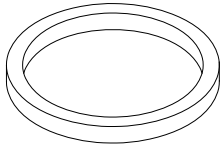

04

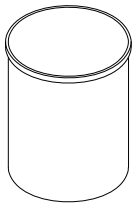

05

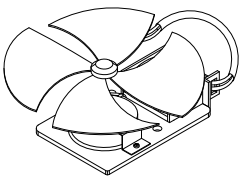

06

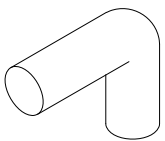

07

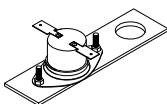

RELAÇÃO CABOS ENTRADA FORÇA 1,0mm²

MODELO	CÓDIGO	DESCRIÇÃO
	300052922	ABNT(BRASIL)
	300052917	NEMA
	300052982	IRAM
	300052928	SCHUKO

08

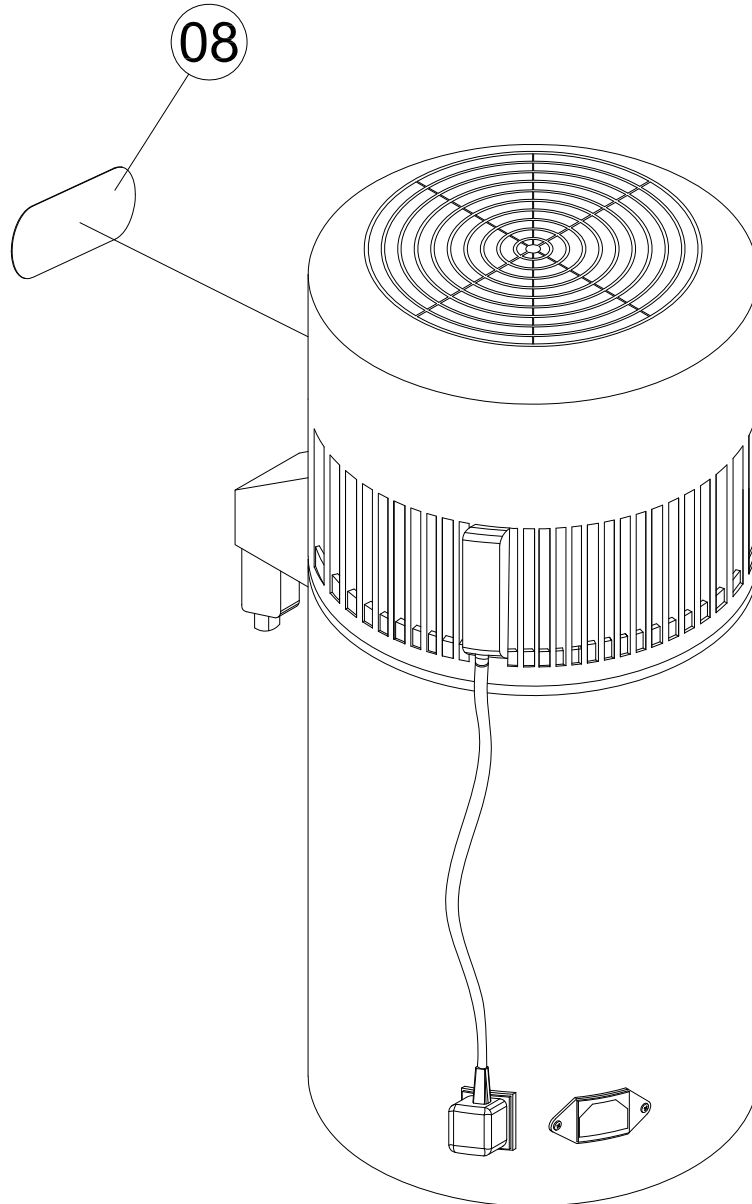

DABI ATLANTE

DESTILADORA BIO AQUA DABI
BIO AQUA DISTILLER
DESTILADORA BIO AQUA

REV. 00